



GR200

AM/FM/VHF MARINE BROADCAST RADIO



INSTRUCTION MANUAL

CONTENTS

FEATURES	3
ACCESSORIES SUPPLIED.....	3
OPTIONAL ACCESSORIES.....	3
COMPLIANCE	4
LISTENING TO FM IN YOUR BOAT	4
LCD DISPLAY.....	4
CONTROLS.....	5
Power Key.....	5
Mode Key	5
Band Key	5
Up/Down Keys	6
Memory Keys	6
OPERATION	6
Turning the GR200 On and Off.....	6
Adjusting the Sound.....	6
Tuning for Stations	8
Memory Keys	9
Automatic Memory Storage.....	9
Local/DX Mode	10
Stereo/Mono Mode	10
INSTALLATION	10
Mounting the GR200	11
ELECTRICAL WIRING	12
SPECIFICATIONS	14
SC CONTRACT WARRANTY AGAINST DEFECTS.....	15
BRANCH ADDRESSES	BACK PAGE

FEATURES

- Compact design with bracket or flush mounting options
- Ingress Protection to IP55*
- 7 bands (LW, SW, AM1, AM2, FM1, FM2, VHF)
- 6 preset frequency memories per band
- Simple push button controls.
- Front panel 'monitor' speaker
- Large white backlit display with 'dim' feature
- FM stereo reception
- Bass, treble and balance controls
- Separate bass and treble memories for each band
- Over voltage indicator
- Reverse polarity protection
- Static discharge protection at antenna input
- User selectable VHF frequencies and NOAA weather channels
- Auxiliary audio input
- Available in black or white

ACCESSORIES SUPPLIED

- 2 x extension speaker leads – 3.5 mm mini jack
- Mounting bracket, gimbal knobs and stainless steel screws
- DC supply lead
- Instruction manual

OPTIONAL ACCESSORIES

- In-dash flush mounting kits – MK100W (white), MK100B (black), MK002W, MK002B
- Rear flush mount kit – MK600
- Choose from a range of GME antennas
- Choose from a range of GME speakers
- Cabin cover – CVR001W (white), CVR001B (black)
- Auxiliary input interface cable – LE74

*Refer: www.gme.net.au/IPRatings

COMPLIANCE

This device complies with AS/NZS 61000.6.3:2007.

This device complies with part 15 of the FCC rules. Operation is subject to the condition that this device does not cause harmful interference.

LISTENING TO FM IN YOUR BOAT

The majority of FM broadcasts are music programs. Compared with AM signals, FM signals have a wider dynamic range, are relatively immune to noise and provide virtually distortion free music reproduction. However, because of the nature of FM signals and the fact that FM stations are usually positioned for shore based reception, reception in a moving boat may be accompanied by problems.

FM programs are broadcast for local reception and may not be heard satisfactorily at distant locations. To enjoy FM programs at their best, it is important that you tune to a station that is broadcasting in your locality.

FM signals can reflect from solid objects such as buildings or hills. If these reflected signals are received along with signals that are arriving directly from the transmitter, they may mix together to produce what is known as 'multipath distortion'. This distortion is heard as noise. Often, moving as little as one metre from your position will correct this problem.

FM signals travel in straight lines. Because the signals are reflected from or absorbed by large solid objects, a signal 'shadow' may be present behind the object which may result in poor reception in that area.

LCD DISPLAY

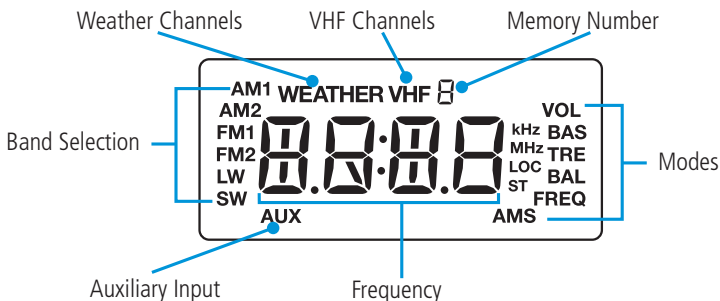

CONTROLS

POWER KEY ①

Press and hold the **Power** key ① to turn the GR200 ON or OFF. While the radio is ON briefly press the **Power** key ① to toggle the audio mute function. 'MUTE' will flash on the display when the mute function is activated.

MODE KEY (M)

The Mode key provides access to the Volume, Bass, Treble, Balance, Frequency Adjustment, Automatic Memory Store (AMS) and Local/DX settings.

The Mode selection will automatically return to the Volume setting 20 seconds after the last key press.

BAND KEY (B)

The GR200 has 7 selectable frequency bands plus an Auxiliary audio input. The frequency bands available are Long Wave (LW), Short Wave (SW), AM (AM1 and AM2), FM (FM1 and FM2) and VHF Marine (VHF). The Auxiliary input mode allows audio from external sources such as MP3 players to be connected via a 3.5 mm socket lead on the rear panel.

The frequency coverage of each band is listed in the specifications on page 14 of this manual.

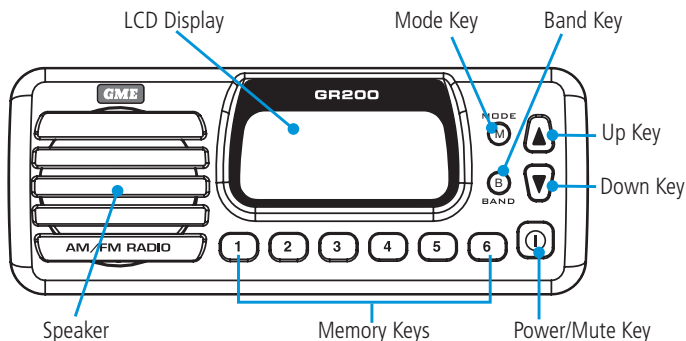

UP/DOWN KEYS ▲ ▼

The Up and Down keys are used to adjust functions selected using the Mode key.

MEMORY KEYS ① ② ③ ④ ⑤ ⑥

Six memory keys are provided for storage and retrieval of station memories.

OPERATION

TURNING THE GR200 ON AND OFF

To switch the GR200 **on**, press and hold the ① key for two seconds.
The radio will turn ON.

To switch the GR200 **off**, press and hold the ① key for two seconds.
The radio will turn OFF.

.....
NOTE: When the GR200 is switched off or the power is interrupted, it will remember the last state that it was set to and return to that state when it is switched back on.
.....

ADJUSTING THE SOUND

Adjusting the Volume

During normal use, the GR200 will default to the volume mode. Whenever the volume mode is selected 'VOL' is displayed on the right of the LCD. If you are not in the volume mode, briefly press the **Mode** key repeatedly until 'VOL' is displayed on the LCD.

To adjust the volume, press the ▲ or ▼ key. Pressing the ▲ key will increase the volume while pressing the ▼ key will decrease the volume. The volume setting will be displayed on the LCD. Minimum volume setting displays a value of 0 with a maximum volume setting of 30. To quickly adjust the volume setting, press and hold the ▲ or ▼ key.

Adjusting the Bass

To select the bass mode, briefly press the **Mode** key repeatedly until **BAS** is displayed on the right of the LCD. To adjust the bass, press the ▲ or ▼ key. Pressing the ▲ key will increase the bass while pressing the ▼ Key will decrease the bass. The bass setting will be displayed on the LCD. Minimum bass setting displays a value of -7 with a maximum bass setting of +7. A setting of 0 indicates a flat bass response. To quickly adjust the bass setting, press and hold the ▲ or ▼ key.

Adjusting the Treble

To select the treble mode, briefly press the **Mode** key repeatedly until 'TRE' is displayed on the right of the LCD. To adjust the treble, press the ▲ or ▼ key. Pressing the ▲ key will increase the treble while pressing the ▼ key will decrease the treble. The treble setting will be displayed on the LCD. Minimum treble setting displays a value of -7 with a maximum treble setting of +7. A setting of 0 indicates a flat treble response. To quickly adjust the treble setting, press and hold the ▲ or ▼ key.

Adjusting the Balance

The balance setting controls the audio balance between the left and right speaker.

NOTE: The balance mode is only available when the external speakers are attached. If running the GR200 from the internal monitor speaker, the balance function is skipped when the **Mode** key is pressed.

Briefly press the **Mode** key repeatedly until 'BAL' is displayed on the right of the LCD. To adjust the Balance, press the ▲ or ▼ key. Pressing the ▲ key will adjust the balance towards the left speaker while pressing the ▼ Key will adjust the Balance towards the right speaker. The Balance setting will be displayed on the LCD. Full left balance displays a value of L10 with a full right balance setting of R10. A setting of 0 indicates the balance is set equally between both speakers. To quickly adjust the Balance setting, press and hold the ▲ or ▼ key.

Muting the Sound

The Mute feature allows the radio's sound to be temporarily disabled without affecting any other settings. This is useful when making calls on your two way radio or mobile phone or during a local conversation where the radio sound is distracting.

To temporarily mute the radio, briefly press the Ⓜ key. The audio will be temporarily disabled and no sound will be heard from the speaker(s). While the sound is muted, 'MUTE' will flash on the display.

To cancel the Mute selection and restore the sound to its previous level, briefly press the Ⓜ key again.

Dimming the Display

The display lighting can be dimmed for night time viewing. The default setting is maximum brightness. To dim the display:

1. Press and hold the Ⓜ key to turn the GR200 OFF.
2. Now press and hold the Ⓜ key again. The GR200 will turn on. DON'T RELEASE THE Ⓜ KEY YET.
3. Now briefly press the **M** key to toggle the display lighting dim or bright. Once you have selected the display lighting you can release the Ⓜ key.

TUNING FOR STATIONS

Selecting the Frequency Band

The GR200 has 7 selectable frequency bands plus an Auxiliary audio input. The frequency bands available are Long Wave (LW), Short Wave (SW), Medium Wave (AM1 and AM2), FM (FM1 and FM2) and VHF Marine (VHF). The Auxiliary input mode allows audio from external sources such as MP3 players to be connected via a 3.5 mm socket lead on the rear panel.

To select the desired frequency band (or the Auxiliary input) briefly press the **Band** key. Each press will advance to the next band in the sequence and the corresponding symbol LW, SW, AUX, AM1, AM2, FM1, FM2 or VHF will appear on the display to confirm your selection. Note that when the AUX input is selected, 'In' will also be displayed when an external device is connected.

The frequency coverage of each band is listed in the specifications on page 14 of this manual. For information on the 'AUX' selection please see 'Auxiliary Input' on page 13.

Selecting USA or European Receiver Standards

The GR200 supports USA, Canadian and European standards for AM and FM reception. Australian models conform to the European standard and are set that way by default. Owners in the USA or Canada should select the USA or Canadian standard.

To switch between the standards, press and hold the **Band** key for 3 seconds. The GR200 will display 'E' at the top of the display for European, 'U' for USA or 'C' for Canada. The 'E', 'U' or 'C' symbols will disappear once any of the memory preset buttons are pressed.

The differences between the European, USA and Canadian bands are listed in the specifications on page 14 of this manual.

NOTE: When the VHF marine band is selected, switching between USA, Canadian and European standards will also select USA, Canadian or International VHF marine channel allocations.

Manually Tuning the Frequency

Briefly press the **Mode** key repeatedly until 'FREQ' is displayed on the right hand side of the LCD. You can now manually change the frequency. To adjust the frequency, briefly press the ▲ or ▼ key. Pressing the ▲ key will increase the frequency while pressing the ▼ key will decrease the frequency. The frequency will be displayed on the LCD.

Scanning for Stations

While in frequency tuning mode, press and hold the ▲ or ▼ key for 3 seconds. The GR200 will automatically scan upwards or downwards in frequency starting at the present frequency. When a station is found, scanning will stop on that frequency.

NOTE: When tuning in the VHF band, standard VHF marine channel numbers 1-28 and 60-88 are displayed. If the USA or Canadian standard is selected, an additional ten NOAA weather channels are also available. When these are selected, 'WEATHER' is displayed on the LCD.

MEMORY KEYS

The GR200 has 6 preset memory keys which allow up to 6 frequencies to be stored and recalled within each band. Because there are two identical AM bands and two identical FM bands, this allows 12 AM and 12 FM preset memories. The memories can be stored either manually or automatically.

Manually Locating and Storing Station Frequencies in the Preset Memories

1. Press the Band key repeatedly until the required band is selected.
2. Press the **Mode** key repeatedly until the frequency adjustment mode is selected ('FREQ' will be displayed).
3. Press the ▲ or ▼ key briefly to manually step through the frequencies. To automatically scan for the next station, press and hold the ▲ or ▼ key.
4. Once the required station has been located, press and hold one of the six **memory keys** for 3 seconds. The frequency will flash and the sound will mute briefly as the frequency is stored into the selected memory. The selected memory number will be displayed at the top of the LCD.

Repeat steps 3 and 4 above to store other frequencies into the preset memories.

NOTE: If a frequency or VHF marine channel is selected that is already stored in memory, the allocated memory number will also be displayed.

Recalling Stations from the Preset Memories

Select the required band, then briefly press the required **memory** button. The GR200 will switch to the frequency stored in that memory location and the selected memory number will be displayed at the top of the LCD.

AUTOMATIC MEMORY STORAGE (AMS)

The AMS feature allows the GR200 to search the selected band for stations and automatically store the first six strongest stations it locates into the station memories. While activated, the Local (LOC) receiver sensitivity mode is temporarily enabled to ensure only stronger local stations are selected.

To activate the AMS feature, briefly press the **Mode** key repeatedly until 'AMS' is displayed on the lower right of the LCD. To begin the search, press the ▲ or ▼ key. Pressing the ▲ key will cause the GR200 to search upwards through the frequencies while pressing the ▼ key will cause it to search downwards. The search will begin from the last displayed frequency. As strong stations are found they will be automatically stored into the station memories. When all six memories have been filled, or the entire band has been searched, the search will stop and the station in Memory 1 will be selected.

To manually stop the memory search, briefly press the ▲ or ▼ key. To change the search direction, briefly press the opposite key after the search has been manually stopped.

LOCAL/DX MODE

The Local/DX mode controls the receiver's sensitivity when in the FM mode. The GR200 can be set to high sensitivity for long distance reception (DX) or low sensitivity for local reception (LOC).

Briefly press the **Mode** key repeatedly until AMS is selected then press ONCE more to access the LOC function. Press the ▲ or ▼ keys to toggle LOCAL or DX modes. A solid LOC symbol on the display indicates LOCAL mode is selected. If the LOC symbol is flashing then DX mode is selected.

When the GR200 returns to the normal display mode, LOC will be displayed if Local mode is selected. If LOC is not visible then DX mode is selected.

STEREO/MONO MODE

The Stereo/Mono function can be selected on the FM band when the external stereo speakers are attached. If the GR200 is only operating from the internal monitor speaker, Mono/Stereo selection is not available.

Mono

Selecting Mono improves the quality of the reception when FM signals are weak or noisy by disabling stereo detection. When Mono is selected, there is no indication on the display.

Stereo

Select stereo for normal stereo listening on the FM bands. When Stereo is selected and a stereo signal is being received, 'ST' is displayed.

To switch between Mono and Stereo modes, press and hold the **Mode** key for 3 seconds. The ST icon will appear or disappear indicating the current selection.

INSTALLATION

Rear Panel Connections

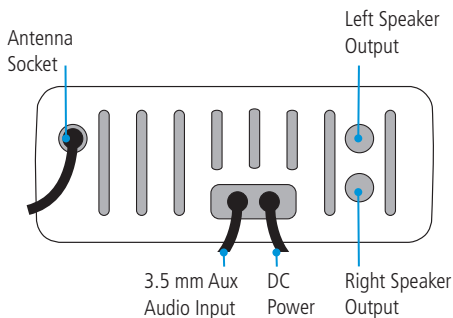

MOUNTING THE GR200

The GR200 is designed to be mounted in several different ways to enable it to be installed in the most convenient position. The GR200 is designed to meet IP55 Standard (Refer: www.gme.net.au/IPRatings). A location should be selected which provides the best viewing angle for the display. For best results select a location that is free from excessive vibration and continuous direct sunlight.

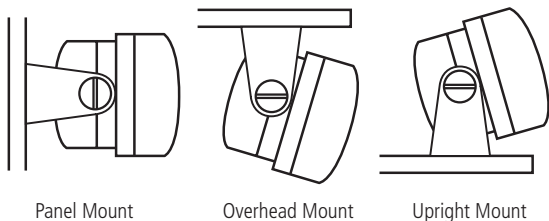

Upright or Overhead Mounting

Position the mounting bracket onto the GR200 so that the mounting holes in the bracket align with those on the side of the unit, and fit the gimbal knobs. Temporarily position the bracket in the desired location and roughly mark the bracket edges. Now remove the unit from the bracket and reposition the bracket to mark the mounting holes. Screw or bolt the bracket into position. The mounting method will depend on the surface to which the bracket is being attached. Refit the GR200 to the bracket and adjust the unit to the correct position before tightening the gimbal knobs.

Complete the antenna lead and electrical wiring as described later.

Flush Mounting

If you require to flush mount your GR200 we recommend the MK100 flush mounting kit designed especially for the purpose. Instructions and a mounting template are included with the kit.

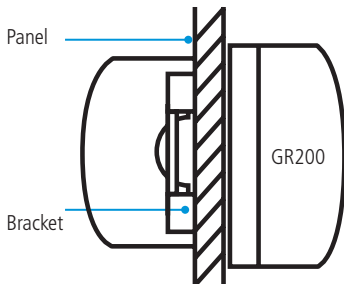

ELECTRICAL WIRING

The GR200 is suitable for either negative or positive ground systems.

NOTE: The GR200 has an over voltage detector to indicate when excessive voltage is being applied to the radio. The over voltage detector is triggered when the voltage being applied to the power leads exceeds 18 volts DC. If this happens, the words 'hi dc' will flash on the display. If the voltage exceeds 21 volts DC, the radio will automatically shut down.

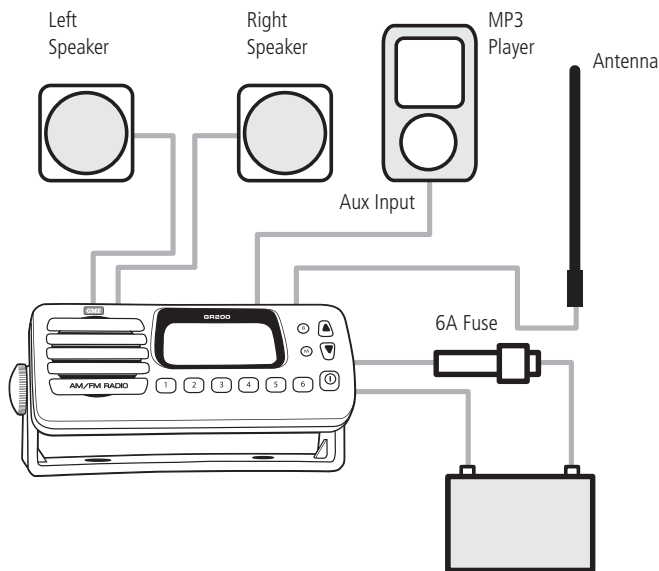

Referring to the Wiring Diagram

1. Connect the RED fused wire directly to the positive terminal of the battery or to a point in the vessels electrical wiring that provides a +12 Volt connection.
2. Connect the Black negative wire directly to the battery's negative terminal or to a negative point in the vessels wiring.

Speaker Connections

NOTE: For simple installations, the GR200 can be used without external speakers if required. The GR200's internal monitor speaker can provide good quality mono sound suitable for many applications. For full stereo sound you will need to connect a pair of external speakers. The GR200's internal monitor speaker is automatically disconnected when the external speakers are plugged in.

The GR200 is supplied with two speaker adapter leads which are designed to accept the standard bullet connectors found on some GME marine speakers and most marine and automotive speaker cables. The plugs on the speaker adapters plug into the matching the sockets on the rear of the GR200. The plugs are fitted with protective flexible covers.

When connecting the speakers, observe the correct polarity as shown in the diagram. Incorrect polarity will result in a reduction of bass response and stereo effect. The use of speakers with an impedance of less than 4 Ohms is not recommended as they will cause excessive loading of the GR200's output circuit.

The GR200 is a two speaker system that requires one pair of wires for each speaker. Avoid shorting the speaker wires together or touching them to the supply voltage or to ground.

Once the GR200 is connected, you can adjust the balance between the left and right speaker using the Balance function.

Auxiliary Audio Input

Connect an MP3 player or other external audio device to the 3.5 mm socket on the Auxiliary Input lead mounted on the rear panel. To select the AUX input, press the **Band** key repeatedly until 'AUX' 'In' is displayed.

A 3.5 mm to 3.5 mm accessory lead (LE74) is available separately from your GME dealer.

Antenna Connection

The antenna should be mounted in a position as high as practical to ensure good reception especially in areas of low signal strength. When installing the antenna, ensure a minimum clearance of around 20 cm from bow or stern rails or windscreen frames etc. It is also recommended the antenna be placed at least one metre from two-way radio antennas to minimise interference from radio transmissions.

To connect the antenna to your GR200, simply plug the antenna lead into the flying antenna socket on the rear of the unit.

Waterproofing the Connections

After installation, the power, speaker and antenna connectors should be wrapped in waterproof tape or similar to minimise the risk of corrosion or water damage. Do not use normal electrical tape as this will not provide an adequate seal against water. The connectors should then be positioned where they are not directly exposed to the elements.

Fuse Replacement

If the fuse in the DC lead should blow, it should be replaced with a 6 Amp 3AG type. In the event of a failure, the use of a higher value fuse could result in damage to your GR200 which would void the warranty.

SPECIFICATIONS*

General

Complies with:	AS/NZS 61000.6.3:2007
Frequency Range:	LW, MW, SW, VHF, AM and FM
Channel Set:	Broadcast Radio Bands and VHF Marine Band
Scan Speed:	100 ms/channel
Supply Voltage Range:	10.8 – 15.6 V DC negative earth
Current Protection:	6 Amp 3AG fuse
Reverse Polarity & Over Voltage Protection:	'hi dc' at 18 V shutdown at 21 V

Receiver

LW Frequency Range:	144 – 430 kHz, 1 kHz step
SW Frequency Range:	2-10 MHz, 5 kHz step
MW (AM) Frequency Range:	522 – 1710 kHz, 9 kHz step (EU/AUS/NZ) 530 – 1710 kHz, 10 kHz step (USA/CANADA)
FM Frequency Range:	87.5 – 108 MHz, 100 kHz step (EU/AUS/NZ) 87.5 – 108 MHz, 100 kHz step (USA/CANADA)
VHF FM Marine Band:	155 – 165 MHz, 25 kHz step
IF Frequencies:	1st: 10.7 MHz, 2nd: 450 kHz
Modulation Frequency Response:	60 Hz – 15 kHz for FM
Adjacent Channel Rejection:	> 73 dB
Intermodulation Rejection:	> 73 dB
Blocking Rejection:	> 90 dB
Spurious Rejection:	> 75 dB
Audio Output Power:	2 x 40 watts P-P (2 x 15 watt Rms)
Audio S/N:	> 45 dB
Conducted Spurious Emission:	< -70 dB
Current Consumption:	Full Volume: < 5 Amps

Sensitivity

AM:	-101 dBm 20 dB SINAD
FM:	-101 dBm 30 dB SINAD
VHF:	-105 dBm 12 dB SINAD

Mechanical

Unit Dimensions:	164 (W) x 65 (H) x 70 (D) mm
Unit Weight:	482 g approx.
Flush Mounting Depth:	55 mm min.

Environmental

Ingress Protection Rating:	IP55 - Refer: www.gme.net.au/IPRatings
Temperature Range:	-10°C to +60°C
Solar Radiation:	Case UV stabilised
Compass Safe Distance:	200 mm

External connections

- DC Supply: 2 Pin polarised plug socket
External Speakers: 3.5 mm mini phone jacks
Auxiliary input: 3.5 mm stereo phone jack
-

***All specifications are typical and subject to change without notice or obligation.**

STANDARD COMMUNICATIONS WARRANTY AGAINST DEFECTS

This warranty against defects is given by Standard Communications Pty Ltd ACN 000 346 814 (We, us, our or GME). Our contact details are set out in clause 2.7. This warranty statement only applies to products purchased in Australia. Please contact your local GME distributor for products sold outside of Australia. Local distributor details at www.gme.net.au/export.

1. Consumer guarantees

- 1.1 Our goods come with guarantees that cannot be excluded under the Australian Consumer Law. You are entitled to a replacement or refund for a major failure and for compensation for any other reasonably foreseeable loss or damage. You are also entitled to have the goods repaired or replaced if the goods fail to be of acceptable quality and the failure does not amount to a major failure.
- 1.2 To the extent we are able, we exclude all other conditions, warranties and obligations which would otherwise be implied.

2. Warranty against defects

- 2.1 This warranty is in addition to and does not limit, exclude or restrict your rights under the Competition and Consumer Act 2010 (Australia) or any other mandatory protection laws that may apply.
- 2.2 We warrant our goods to be free from defects in materials and workmanship for the warranty period (see warranty table) from the date of original sale (or another period we agree to in writing). Subject to our obligations under clause 1.2, we will at our option, either repair or replace

goods which we are satisfied are defective. We warrant any replacement parts for the remainder of the period of warranty for the goods into which they are incorporated.

- 2.3 To the extent permitted by law, our sole liability for breach of a condition, warranty or other obligation implied by law is limited
- (a) in the case of goods we supply, to any one of the following as we decide -
 - (i) the replacement of the goods or the supply of equivalent goods;
 - (ii) the repair of the goods;
 - (iii) the cost of repairing the goods or of acquiring equivalent goods;
 - (b) in the case of services we supply, to any one of the following as we decide -
 - (i) the supplying of the services again;
 - (ii) the cost of having the services supplied again.
- 2.4 For repairs outside the warranty period, we warrant our repairs to be free from defects in materials and workmanship for three months from the date of the original repair. We agree to re-repair or replace (at our option) any materials or workmanship which we are satisfied are defective.
- 2.5 We warrant that we will perform services with reasonable care and skill and agree to investigate any complaint regarding our services made in good faith. If we are satisfied that the complaint is justified, and as our sole liability to you under this warranty (to the extent permitted at law),

we agree to supply those services again at no extra charge to you.

2.6 To make a warranty claim you must before the end of the applicable warranty period (see warranty table), at your own cost, return the goods you allege are defective, provide written details of the defect, and give us an original or copy of the sales invoice or some other evidence showing details of the transaction.

2.7 Send your claim to:
Standard Communications Pty Ltd.
Unit B, 22-24 College Street,
Gladesville, NSW 2111, Australia.
Tel: (02) 9879 8888
Fax: (02) 9816 4722
Email: servadmin@gme.net.au

2.8 If we determine that your goods are defective, we will pay for the cost of returning the repaired or replaced goods to you, and reimburse you for your reasonable expenses of sending your warranty claim to us.

3. What this warranty does not cover

- 3.1 This warranty will not apply in relation to:
- (a) goods modified or altered in any way;
 - (b) defects and damage caused by use with non Standard Communications products;
 - (c) repairs performed other than by our authorised representative;
 - (d) defects or damage resulting from misuse, accident, impact or neglect;
 - (e) goods improperly installed or used in a manner contrary to the relevant instruction manual; or
 - (f) goods where the serial number has been removed or made illegal.

4. Warranty period

- 4.1 We provide the following warranty on GME and Kingray products. No repair or replacement during the warranty period will renew or extend the warranty period past the period from original date of purchase.

PRODUCT TYPE	WARRANTY PERIOD
Land and marine stereo systems	1 year



A division of Standard Communications Pty Ltd.

Head Office: PO Box 96, Winston Hills, NSW 2153, Australia.

New Zealand: PO Box 58-446 Botany, Auckland, 2163, NZ. T:(09) 274 0955.

All other international enquires email: export@gme.net.au

MK600 IN DASH FITTING INSTRUCTIONS

REAR VIEW

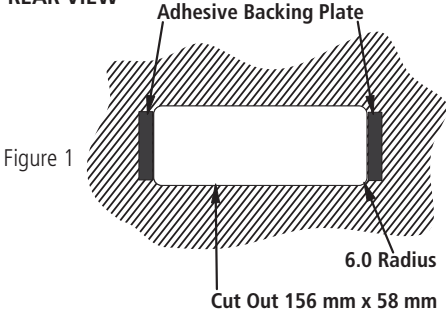

Figure 1

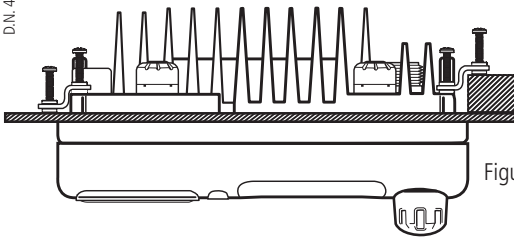

Figure 2

Ensure that the location selected for in dash mounting is convenient for the operator and that there is sufficient space behind the panel to accommodate the body of the radio and allow a free flow of air. Refer to page 13 of the Instruction Manual for more hints.

Once the most suitable location has been selected, mark and centre punch the cross hair in each corner and drill a 12 mm diameter hole. Mark a straight line from the outer edge of each hole to form a rectangle. Cut to the inside edge of these lines.

Remove the backing paper from the metallic backing strips exposing the self adhesive surface and fix them in position vertically at either end of the hole on the rear side of the dashboard flush with the edge. See figure 1

Place the GX600 through the hole. If the dashboard is subject to water spray it may be beneficial to apply a thin bead of sealant to prevent any water ingress between the body of the radio and the dashboard.

The S/S brackets can now be fastened to the rear panel of the GX600 with the 4 S/S self tappers supplied. Note that the brackets can be reverse mounted to allow for varying thicknesses of dashboards. See figure 2

Insert the remaining metal-thread screws so that they bear down on the two metallic backing strips and tighten until the GX600 is held firmly in place.

Connect the power lead and antenna lead as illustrated in the Instruction Manual.

Contents:

- 2 S/S brackets
- 2 adhesive backing strips
- 4 S/S self tapping screws
- 4 S/S metal-thread screws

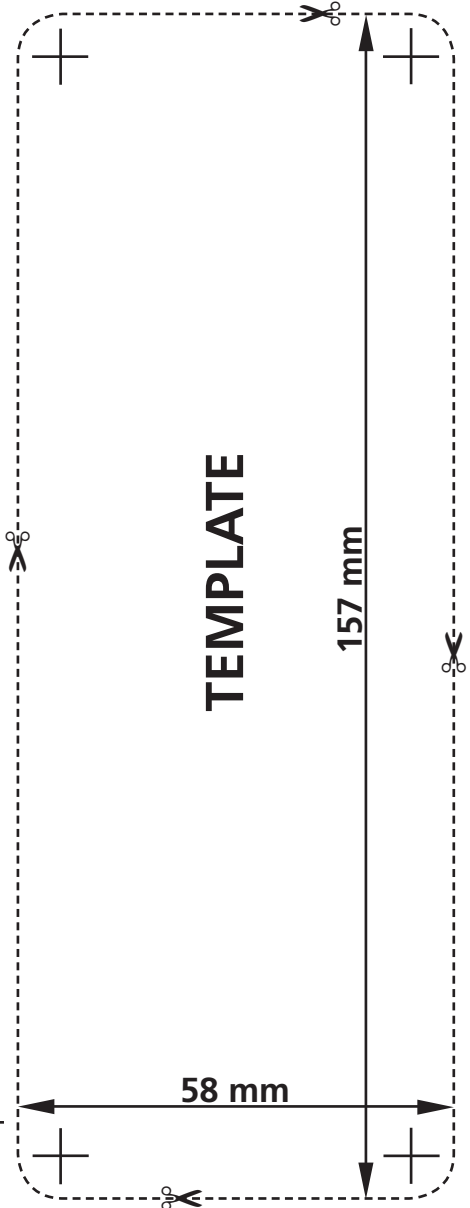

Head Office: PO Box 96, Winston Hills, NSW 2153, Australia
A division of Standard Communications Pty Ltd.

1300 463 463 gme.net.au

MIKOO I B INSTALLATION - CUTTING TEMPLATE

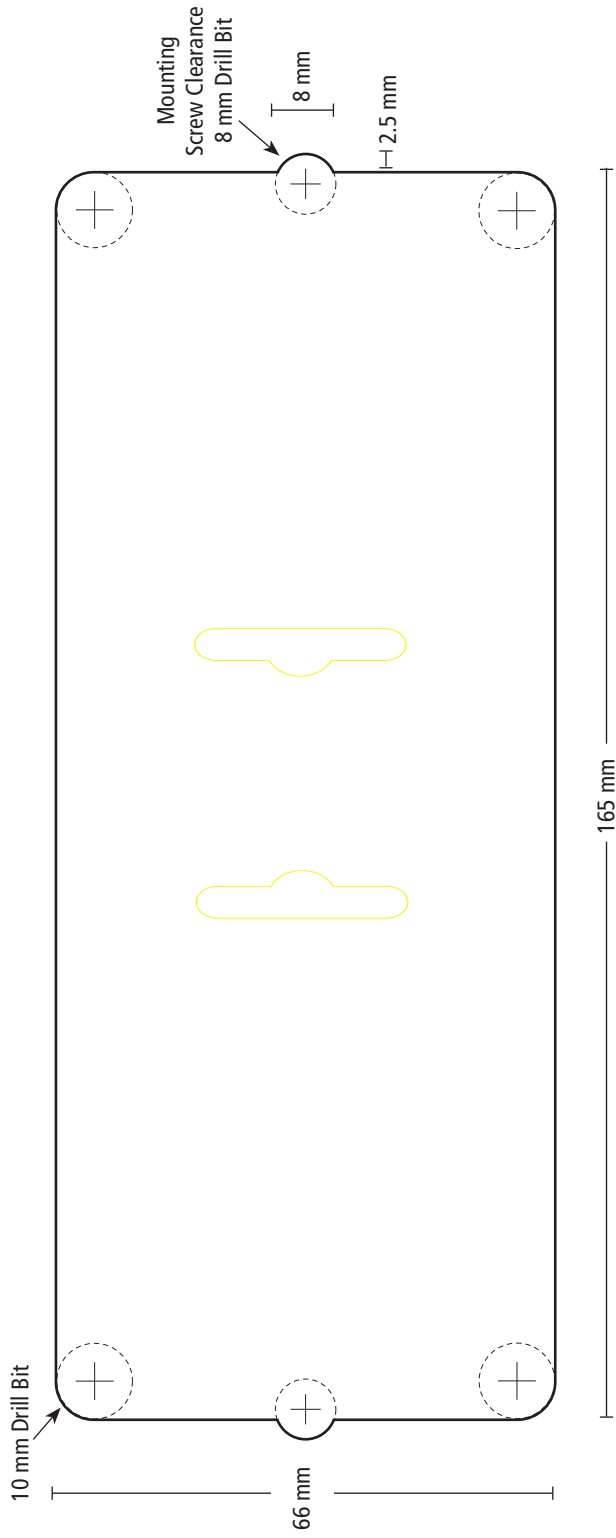

Mark and cut a hole 66 mm (h) by 165 mm (w), allowing for clearance of the two mounting screws holding the radio to the surround.
Use a 10 mm drill bit to form the radius of the corners and an 8 mm drill bit for the clearance of the mounting screws.

MKOOIW INSTALLATION - CUTTING TEMPLATE

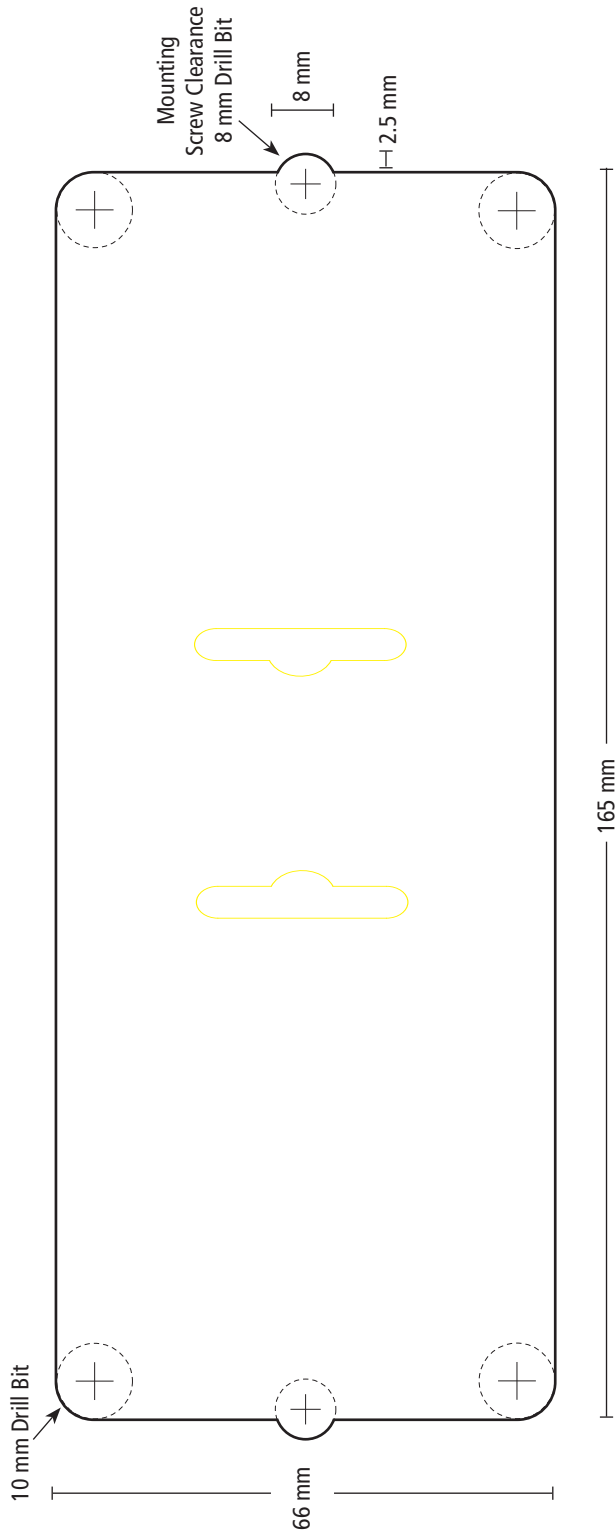

Mark and cut a hole 66 mm (h) by 165 mm (w), allowing for clearance of the two mounting screws holding the radio to the surround.
Use a 10 mm drill bit to form the radius of the corners and an 8 mm drill bit for the clearance of the mounting screws.