

ST1000 Plus & ST2000 Plus Tiller Pilots

Owner's Handbook

Document number: 81130-3
Date: June 2001

Autohelm, HSB (High Speed Bus), SailPilot, SeaTalk and SportPilot are registered trademarks of Raymarine Ltd.

Raymarine, AST (Advanced Steering Technology), AutoAdapt, AutoLearn, AutoRelease, AutoSeastate, AutoTack, AutoTrim, FastTrim, GyroPlus, RayGyro, RayPilot and WindTrim are trademarks of Raymarine Ltd.

Handbook contents © Raymarine Ltd 2001.

Contents

Chapter 1: Introduction	1
1.1 Overview	1
1.2 Specifications	2
1.3 About this handbook	3
Important Information	3
Chapter 2: Using the Tiller Pilot	7
2.1 Overview	7
2.2 Using Auto mode	8
Engaging the autopilot (Auto mode)	8
Disengaging the autopilot (Standby mode)	8
Changing course	9
Displaying navigation information pages	12
Automatic deadband control (Auto Seastate)	12
Operating hints – trim changes	13
2.3 Switching display illumination on and off	14
2.4 Using Track mode	15
Selecting Track mode	15
Returning to Auto from Track mode	17
Cross track error (XTE)	17
Tidal stream compensation	18
Waypoint arrival and advance	19
Dodges in Track mode	19
Safety in Track mode	20
Warning messages in Track mode	21
2.5 Using WindTrim mode	23
Selecting WindTrim mode	23
Exiting WindTrim mode	24
Returning to the previous apparent wind angle	24
Wind shift alarm	24
Operating hints for WindTrim mode	25
Chapter 3: Maintenance & Fault Finding	27
3.1 General maintenance	27
3.2 Product support	28
3.3 Fault finding	28
Chapter 4: Installing the Tiller Pilot	33
4.1 Planning the installation	33
4.2 Installing the tiller pin and mounting socket	36
Measuring the critical dimensions	36

Basic installation	37
Installation accessories	38
4.3 Cabling and socket installation	45
Mounting the socket	45
Power supply	46
SeaTalk cabling	47
NMEA cabling	49
Connecting NMEA and SeaTalk	50
Chapter 5: Commissioning the Tiller Pilot	51
5.1 Functional tests	51
Switch on	51
Operating sense	51
Checking the navigation interface	52
Checking the wind instrument interface	54
Checking the SeaTalk interface	54
5.2 Initial sea trial	55
Calibrating the compass	56
Autopilot operation	58
5.3 Adjusting autopilot performance	58
Chapter 6: Adjusting Tiller Pilot Settings	61
6.1 Introduction	61
Adjusting calibration values	61
Calibration features	63
Default calibration values	63
6.2 Calibrating the tiller pilot	64
Calibration Level 1: Rudder gain	64
Calibration Level 5: cruise speed	64
Calibration Level 6: off course alarm angle	64
Calibration Level 9: magnetic variation	65
Calibration Level 10: heading error correction	65
Calibration Level 11: boat's current latitude	66
Calibration Level 13: rudder damping	66
Controlling access to calibration	66
Index	69

Chapter 1: Introduction

1.1 Overview

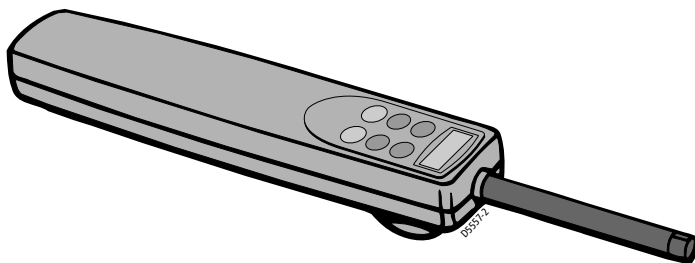

Your Raymarine tiller pilot is a totally self-contained autopilot designed for tiller steered sailboats. The autopilot is mounted between the tiller and a single attachment point on the boat's structure. It is designed for owner installation and is ready for use after connection to the boat's 12 V electrical system.

Operating modes

The tiller pilot has four basic operating modes:

- **Standby mode:** autopilot off
- **Auto mode:** autopilot engaged and locked onto a heading
- **Track mode:** autopilot on and maintaining a track between two waypoints created on a navigation system
- **WindTrim mode:** autopilot on and maintaining a course relative to an apparent wind angle

SeaTalk and NMEA compatibility

The tiller pilot is SeaTalk compatible, so it can share data transmitted from other Raymarine SeaTalk instruments:

- wind information from a wind instrument can be used for wind vane steering without the need to install a separate vane
- track information, from a navigator, enables the autopilot to provide waypoint control
- boat speed from a speed instrument can provide optimum track keeping performance
- SeaTalk compatibility also allows additional fixed and hand-held autopilot control units to be easily connected at secondary steering and control positions

The ST1000 Plus and ST2000 Plus tiller pilots can also be used with any navigator transmitting NMEA 0183 or NMEA 0180 data.

The tiller pilot can be calibrated to suit each installation to provide maximum performance with many types of boat.

1.2 Specifications

General specifications	
Power supply:	10 V to 15 V DC
Drive unit thrust torque:	ST1000 Plus: 57 kg (125 lb) ST2000 Plus: 77 kg (170 lb)
Maximum boat displacement:	ST1000 Plus: 3 000 kg (6 600 lb) ST2000 Plus: 4 500 kg (10 000 lb)
Drive mechanism:	ST1000 Plus: lead-screw and nut drive ST2000 Plus: re-circulating ball drive
Helm speed (lock to lock):	ST1000 Plus: 8 seconds ST2000 Plus: 4.5 seconds
Current consumption:	<ul style="list-style-type: none"> • Standby: 40 mA (90 mA with full lighting) • Auto: 0.5 A to 1.5 A depending on boat trim, helm load and sailing conditions
Operating temperature:	0°C to +70°C (32°F to 158°F)
Main features:	<ul style="list-style-type: none"> • 6 button digital keypad • Backlit LCD display of heading, locked course and navigational information • User calibration for optimum performance • WindTrim control in WindTrim mode • SeaTalk compatible • Automatic compass deviation correction • Northerly/Southerly heading compensation • Automatic heading deadband – seastate control • Automatic tack • Built-in navigator interface (NMEA and SeaTalk) • Waypoint advance feature

EMC conformance

All Raymarine equipment and accessories are designed to the best industry standards for use in the recreational marine environment. The design and manufacture of Raymarine equipment and accessories conform to the appropriate Electromagnetic Compatibility (EMC) standards, but correct installation is required to ensure that performance is not compromised.

1.3 About this handbook

Part 1: Using the Tiller Pilot

This part of the handbook explains how to use your tiller pilot:

2	Chapter 2: Using the Tiller Pilot How to use the tiller pilot.	page 7
3	Chapter 3: Maintenance & Fault Finding Provides maintenance and fault finding information.	page 27

Part 2: Installing the Tiller Pilot

This part of the handbook explains how to install your tiller pilot:

4	Chapter 4: Installing the Tiller Pilot How to install your tiller pilot and its components.	page 33
5	Chapter 5: Commissioning the Tiller Pilot How to check the tiller pilot and perform an initial sea trial.	page 51
6	Chapter 6: Adjusting Tiller Pilot Settings How to change the tiller pilot calibration settings.	page 61

Note: This handbook contains important information about installing, using and maintaining your new Raymarine product. To get the best from the product, please read this handbook thoroughly.

Important Information

Warranty

To register your new Raymarine product, please take a few minutes to fill out the warranty card. It is important that you complete the owner information and return the card to us to receive full warranty benefits.

Handbook information

To the best of our knowledge, the information in this handbook was correct when it went to press. However, Raymarine cannot accept liability for any inaccuracies or omissions it may contain. In addition, our policy of continuous product improvement may change specifications without notice. As a result, Raymarine cannot accept liability for any differences between the product and the handbook.

Safety notices

WARNING: Product installation

This equipment must be installed and operated in accordance with the instructions contained in this handbook. Failure to do so could result in poor product performance, personal injury and/or damage to your boat.

WARNING: Electrical safety

Make sure the power supply is switched off before you make any electrical connections.

WARNING: Navigation aid

Although we have designed this product to be accurate and reliable, many factors can affect its performance. As a result, it should only be used as an aid to navigation and should never replace common sense and navigational judgement. Always maintain a permanent watch so you can respond to situations as they develop.

Your Raymarine autopilot will add a new dimension to your boating enjoyment. However, it is the skipper's responsibility to ensure the safety of the boat at all times by following these basic rules:

- Ensure that someone is present at the helm **AT ALL TIMES**, to take manual control in an emergency.
- Make sure that all crew members know how to disengage the autopilot.
- Regularly check for other boats and any obstacles to navigation – no matter how clear the sea may appear, a dangerous situation can develop rapidly.
- Maintain an accurate record of the boat's position by using either a navigation aid or visual bearings.
- Maintain a continuous plot of your boat's position on a current chart. Ensure that the locked autopilot heading will steer the boat clear of all obstacles. Make proper allowance for tidal set – the autopilot cannot.
- Even when your autopilot is locked onto the desired track using a navigation aid, always maintain a log and make regular positional plots. Navigation signals can produce significant errors under some circumstances and the autopilot will not be able to detect these errors.

Part 1: Using the Tiller Pilot

Part 1: Using the Tiller Pilot

Chapter 2: Using the Tiller Pilot

2.1 Overview

WARNING:

Passage making under autopilot control is an enjoyable experience that can, if you are not careful, lead to the relaxation of the permanent watch. Always maintain a permanent watch no matter how clear the sea may appear to be.

- The tiller pilot always powers up in Standby mode (indicated by a flashing 'C' alongside the boat's current compass heading).
- The tiller pilot is controlled using simple push-button operations, all of which are confirmed with a short beep. In addition to the main single key functions, there are several dual key operations.
- To select automatic steering:
 - steady the boat on the required heading
 - place the pushrod over the tiller pin (if necessary, extend or retract the pushrod using the **-1**, **+1**, **-10**, and **+10** keys)
 - press **auto**: the display will then show an **'A'** alongside the current heading
- To return to manual steering at any time:
 - press **standby**
 - remove the pushrod from the tiller pin
- You can use the **-1**, **+1**, **-10**, and **+10** keys to make course changes when the boat is under autopilot control.

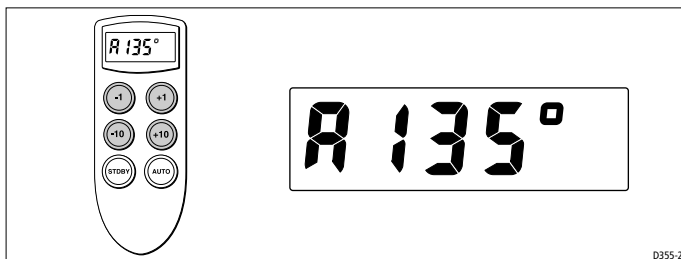

D355-2

2.2 Using Auto mode

Engaging the autopilot (Auto mode)

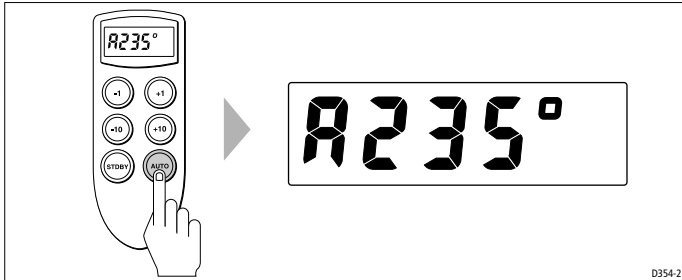

1. Steady the boat on the required heading.
2. Place the pushrod over the tiller pin. If necessary, extend or retract the pushrod using the **-1**, **+1**, **-10**, and **+10** keys.
3. Press **auto**: the tiller pilot will enter Auto mode and the display will show an 'A' (for auto) alongside the locked autopilot heading.

Disengaging the autopilot (Standby mode)



To return to hand steering:

1. Press **standby**.
2. Remove the pushrod from the tiller pin to return to hand steering: the display will show a flashing 'C' and the boat's current compass heading.
3. The last heading is memorized and can be recalled (see *page 11*).

Changing course

In Auto mode, use the **-1** and **-10** (port) and **+1** and **+10** (starboard) keys to change course in steps of 1° and 10° .

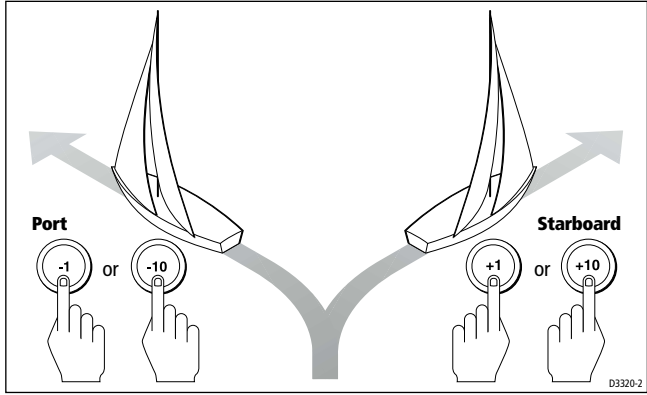

For example: press **-10** three times for a 30° course change to port:

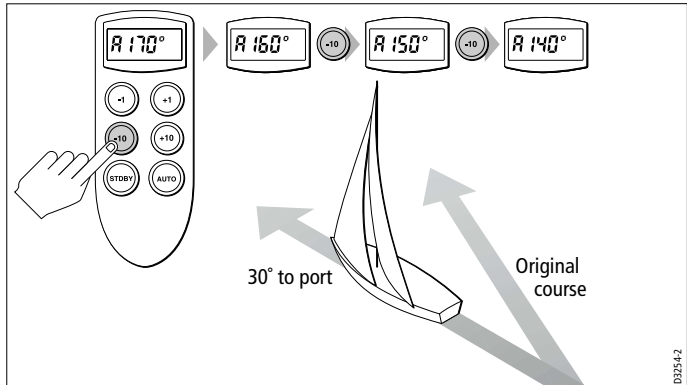

Automatic tack feature (AutoTack)

The autopilot has a built-in automatic tack facility (in Auto, Track and WindTrim modes) that turns the boat through 100°:

- to AutoTack 100° to port, press **-1** and **-10** together
- to AutoTack 100° to starboard, press **+1** and **+10** together

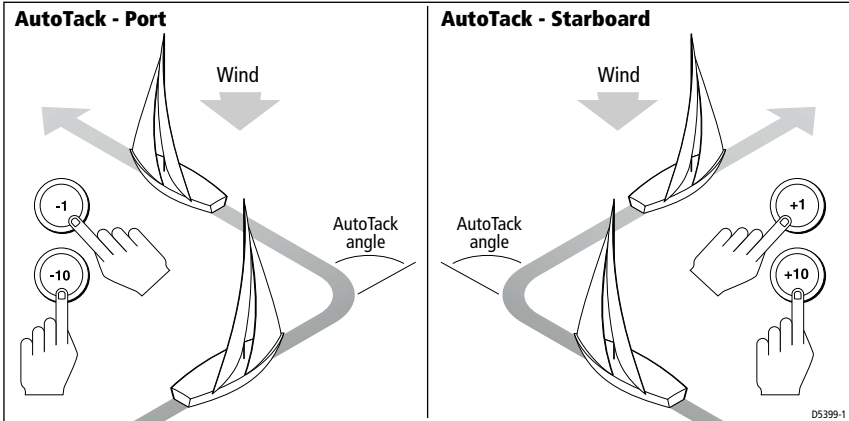

Dodging obstacles

1. To avoid an obstacle when your boat is under autopilot control, select a course change in the appropriate direction. For example, press **-10** three times for a 30° dodge to port.

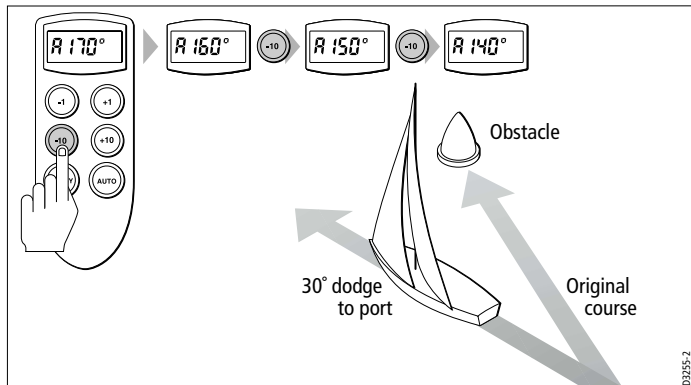

2. When safely clear of the obstacle, you can either:
 - reverse the previous course change (for example, by pressing **+10** three times), or
 - return to the previous heading (see below)

Returning to the previous heading

1. Press **auto** for 1 second: the previous heading will flash for 10 seconds.
2. To accept the previous heading, press **auto** again while the previous heading is flashing.

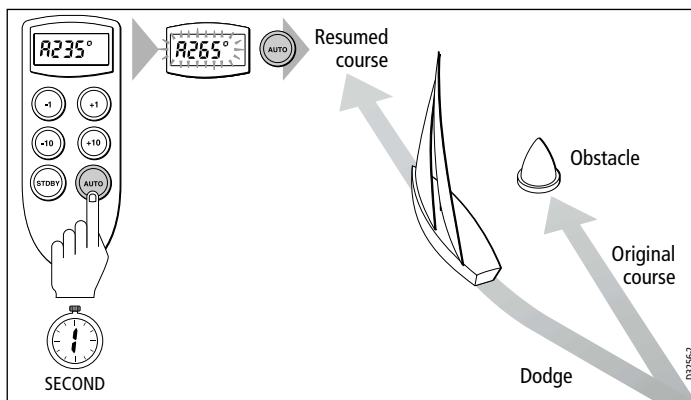

Note: If you do not press **auto** while the display is flashing, the autopilot will maintain the current heading.

Off course alarm

The off course alarm sounds if the locked autopilot heading and the boat's current heading differ by more than the value set in calibration level 6 (see page 64) for 20 seconds.

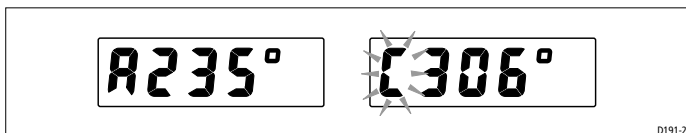

Cancelling the off course alarm

To cancel the off course alarm, press **standby** to return to manual steering.

Note: If the off course alarm sounds, this is usually an indication that the boat is carrying too much sail, or that the sails are badly balanced. In these conditions, you can usually obtain significant improvements in course keeping by improving the sail balance.

Displaying navigation information pages

If navigation information (e.g. distance to waypoint, cross track error and bearing to waypoint) is available, you can display it in Auto mode or Standby mode by pressing either **-1** and **+10** or **+1** and **-10** together momentarily. The display will then cycle through the navigation information pages:

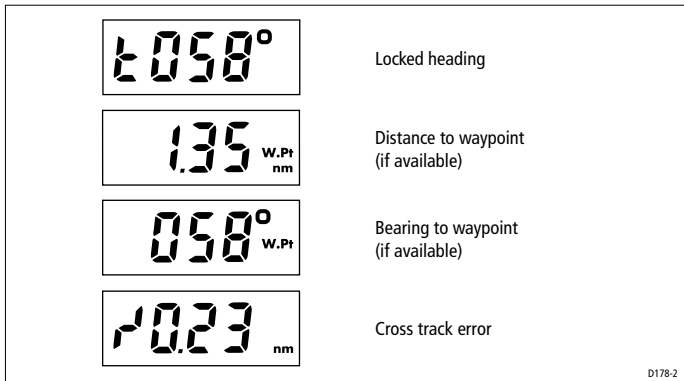

You can revert to normal operation by pressing either **-1** and **+10** or **+1** and **-10** together again.

Automatic deadband control (Auto Seastate)

In Auto, WindTrim or Track modes, the tiller pilot is set to AutoSeastate (automatic deadband control) as a default. This causes the pilot to gradually ignore repetitive movements of the boat and respond only to true course variations.

By preventing unnecessary rudder movement, AutoSeastate provides the best compromise between power consumption and course keeping accuracy.

If you want to switch off the AutoSeastate feature:

1. From Auto, WindTrim or Track mode, press **-1** and **+1** together to switch from AutoSeastate to Fixed Minimum Deadband.
2. The “**o**” sign flashes when Fixed Minimum Deadband is selected. Minimum deadband provides the tightest course keeping possible, at the expense of increased power consumption and drive unit activity.

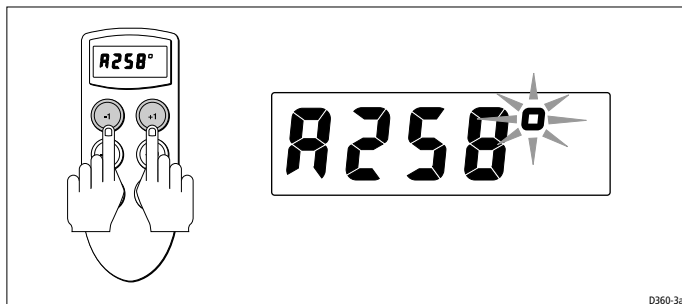

To switch back to AutoSeastate, press **-1** and **+1** again.

Note: *The autopilot reverts to Automatic Deadband Control each time you select Standby mode.*

Operating hints – trim changes

CAUTION:

Only make major course changes when steering MANUALLY. This ensures that the boat will safely clear any obstructions or other boats, and you can take into account the changed wind and sea conditions on the new heading before engaging the autopilot.

Large course changes which change the apparent wind direction can produce large trim changes. When a sudden trim change occurs (for example due to weather helm or sail imbalance) there will be a delay of up to one minute before the automatic trim applies rudder to restore the locked heading.

In these situations, the autopilot will not immediately assume the new automatic heading, and will only settle onto course when the automatic trim has been fully established. To minimize this problem, use the following procedure to make major course changes:

1. Note the required new heading.
2. Press **standby**, remove the pushrod from the tiller pin, and steer manually.
3. Bring boat onto the new heading and fit the pushrod back onto the tiller pin.
4. Press **auto** and let the boat settle on course.
5. Bring your boat onto the final course in 1° steps using **-1** or **+1**.

Gusting conditions

In gusting conditions, the course may tend to wander slightly, particularly if the sails are badly balanced. By improving sail balance, you can improve course keeping.

If you take the following precautions, the autopilot will be able to maintain competent control even in gale force conditions:

- Do not allow the boat to heel over excessively.
- Ease the mainsheet traveller to leeward to reduce heeling and weather helm.
- If necessary, reef the mainsail a little early.
- It is also advisable (whenever possible) to avoid sailing with the wind dead astern when there are very strong winds and large seas.
- Ideally, the wind should be at least 30° away from a dead run.
- In severe conditions, it may be advisable to remove the mainsail altogether and sail under headsail only.

2.3 Switching display illumination on and off

You can switch the display illumination on and off when the tiller pilot is in Standby mode:

- from Standby mode, press **-1** and **+1** together to switch the illumination between on (L1) and off (L0)
- to return to the previous mode either wait 10 seconds or press the appropriate mode key

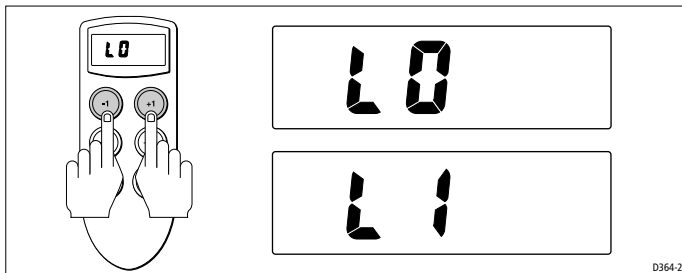

Note: The tiller pilot normally powers-up with the illumination switched on (L1).

If other SeaTalk instruments or autopilot control units are connected via SeaTalk, you can also control the tiller pilot's illumination from these units.

2.4 Using Track mode

In Track mode, the tiller pilot maintains a track between waypoints created on a navigation system. The tiller pilot computes any course changes to keep your boat on track, automatically compensating for tidal streams and leeway. To operate in Track mode, the tiller pilot must receive cross track error information from either:

- a SeaTalk navigator, or
- a non-SeaTalk navigation system transmitting NMEA 0180 or 0183 data

Selecting Track mode

When you select Track mode, the tiller pilot can acquire the track in one of two ways:

- automatic acquisition – when both cross track error and bearing to waypoint data are available
- manual acquisition – when Cross Track Error is the only available information

Automatic track acquisition

If cross track error and bearing to waypoint data are both available (via SeaTalk or NMEA), the pilot can acquire a track automatically:

1. Bring the boat to within 0.1 nm of track.
2. Press **auto**.
3. Press **-10** and **+10** together to enter Track mode.
4. An alarm will sound and the display will alternate between:
 - the bearing to waypoint, and
 - the direction the boat will turn to take up the new track

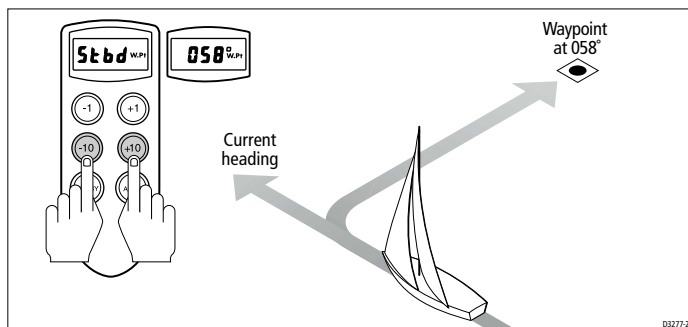

5. Check that it is safe to turn the boat onto the new course.
6. Press **-10** and **+10** together:
 - the boat will now turn on to the new course
 - the alarm will cancel

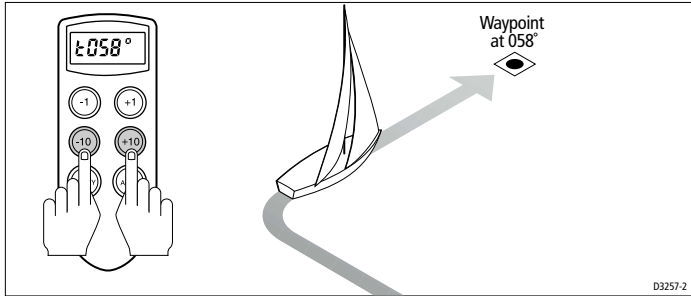

7. The display will continuously cycle through the following navigation information pages:

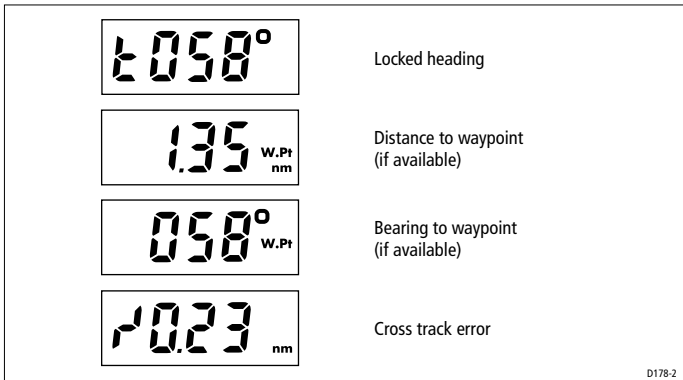

Manual track acquisition

If your navigator only provides cross track error information, you must acquire the track manually:

1. Steer the boat to within 0.1 nm of track.
2. Bring the heading to within 5° of the bearing to the next waypoint.
3. Press **auto**.
4. Press **-10** and **+10** together to enter Track mode:
 - the autopilot will start tracking to the waypoint
 - the display will alternate between cross track error and the locked pilot heading

Manual track acquisition at low speeds

Using manual acquisition at low speeds requires additional care as tidal streams have a far more significant effect at lower speeds than at higher speeds.

In general terms, if the tidal flow is less than 35% of the boat's speed, you will not notice any difference in the tiller pilot's performance in Track mode. However, you should take extra care during manual acquisition, as follows:

- before you select Track mode, make sure that the boat is as close as possible to track, and that the direction made good over the ground is as close as possible to the direction of the next waypoint
- positive checks of the boat's position at regular intervals are vital, especially if you are close to potential navigational hazards

Returning to Auto from Track mode

To return to Auto mode from Track mode:

- press **auto**, or
- press **-10** and **+10** together.

Cross track error (XTE)

Cross track error (XTE) is the distance between your current position and the planned route. This is displayed in nautical miles (nm) and is taken directly from your navigator.

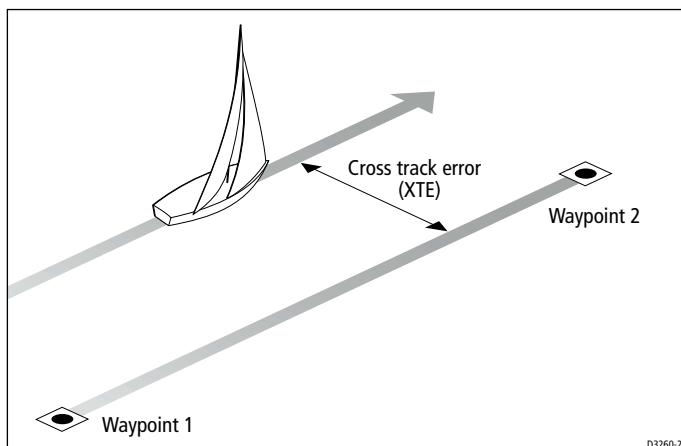

The tiller pilot displays the cross track error in the following ways:

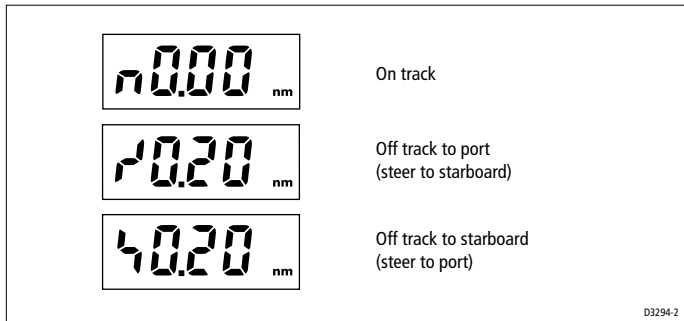

Tidal stream compensation

Under most operating conditions, Track mode will hold the selected track to within ± 0.05 nm (300 ft) or better.

The autopilot takes account of the boat's speed when computing course changes to ensure optimum performance over a wide range of boat speeds. If speed data is available, the autopilot will use the measured boat speed. Otherwise it will use the default cruise speed entered in Calibration Level 5 (see [page 64](#)).

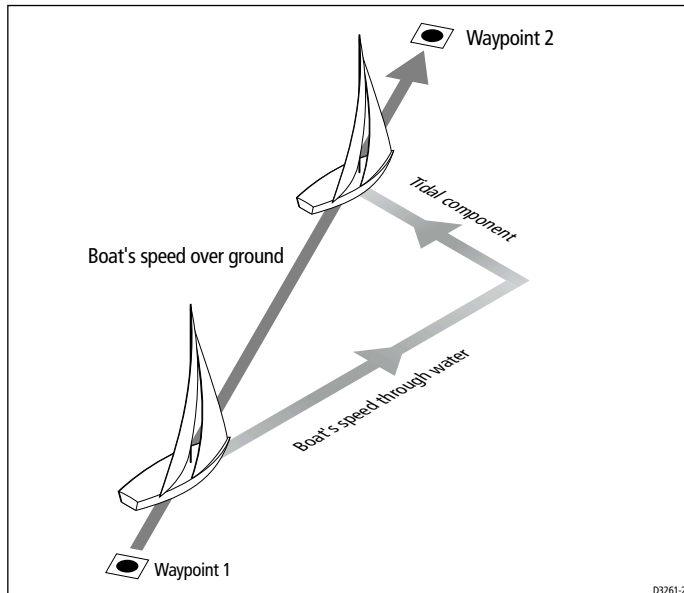

Waypoint arrival and advance

IMPORTANT NOTE:

Waypoint advance will only operate if the tiller pilot receives valid bearing to waypoint and waypoint name information.

The tiller pilot can only decode the first FOUR characters of a waypoint name. It will not be able to decode names longer than four characters, which will stop the waypoint advance feature from working.

If your navigator transmits valid waypoint name and bearing to waypoint data, you can advance from one waypoint to the next by pressing **-10** and **+10** together.

Arrival

As the boat passes the target waypoint, the navigator manually or automatically selects the next target waypoint. The pilot will then:

- detect the new target waypoint name
- sound the waypoint advance alarm
- display the new bearing to waypoint and the direction the boat will turn to acquire it

Advance

When the waypoint advance alarm is sounding, the tiller pilot will suspend Track mode and maintain the current heading:

- check that it is safe to turn onto the new track
- press the **-10** and **+10** keys together: this will cancel the waypoint arrival alarm and turn the boat towards the next waypoint

Unless you accept the waypoint advance in this way, the alarm will continue to sound and the tiller pilot will maintain the current course.

Dodges in Track mode

In Track mode, you still have full control from the keypad:

- to make a dodge maneuver: use the **-1**, **+1**, **-10** or **+10** keys
- after you have avoided the hazard, reverse the course change selected for the dodge maneuver by selecting an equal course change in the opposite direction
- if the boat remains within 0.1 nm of track, there is no need to steer back towards the track

Safety in Track mode

WARNING:

Track mode provides accurate track keeping even in complex navigational situations. However, it is still the skipper's responsibility to ensure the safety of their boat at all times through careful navigation and frequent position checks.

Passage making in Track mode assists precise navigation and removes the tasks of compensating for wind and tidal drift. However, you **MUST** still maintain an accurate log with regular plots:

Confirming position at the start of a journey

- At the start of a journey you must always use an easily identifiable fixed object to confirm the fix given by the navigation system.
- Check for fixed positional errors and compensate for them.

Verifying computed positions

- Always verify the computed position with a dead reckoned position, calculated from the average course steered and the distance logged.

Plot frequency

- In open water, you should make plots at least every hour.
- In confined waters or when near to potential hazards, you should make plots more frequently.

Setting waypoints

- Local variations in radio signal quality and changes in the tidal stream can produce deviations from the desired track. When setting waypoints, remember that deviations can occur.
- Thoroughly check along each track. Check up to 0.5 nm each side of the track to ensure that there are no hazards within this zone.
- For the waypoint advance function to work, the last four characters of adjacent waypoint names must be different.

Warning messages in Track mode

Track data not received

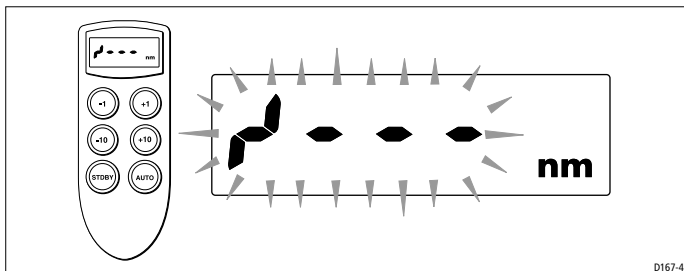

The tiller pilot displays this message if you select Track mode when the autopilot is not receiving any navigation data.

Track data error

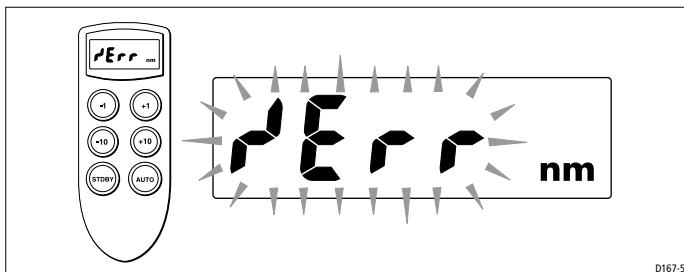

The tiller pilot displays this message if you select Track mode when the navigator has lost its fix. This display will clear as soon as the navigator regains its fix.

Large cross track error

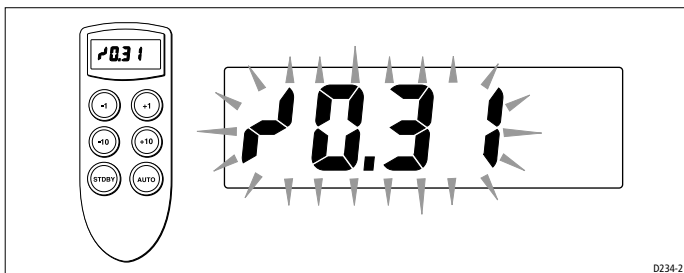

This alarm sounds if cross track error exceeds 0.3 nm.

Waypoint advance

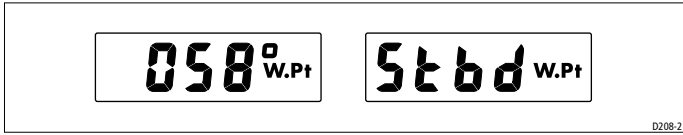

The waypoint advance alarm sounds whenever the target waypoint number changes:

- the pilot continues on its current heading, and the display alternates between the bearing to the next waypoint and the direction the boat will turn to take up that bearing
- make sure that the turn will be safe and, when you are ready to make the turn, momentarily press **-10** and **+10** together.
- the pilot will turn onto the new bearing and track towards the next waypoint

Note: *Waypoint advance will only operate if your pilot receives valid bearing to waypoint and waypoint number information.*

2.5 Using WindTrim mode

Note: You can only use WindTrim mode if the tiller pilot is connected to a suitable wind sensor/instrument providing wind direction data.

To use WindTrim mode, the tiller pilot must receive wind information from one of the following sources:

- SeaTalk wind instrument
- NMEA wind instrument
- Raymarine pushpit wind vane (part number Z159) connected via supplied SeaTalk interface

In WindTrim mode the tiller pilot maintains a course relative to an apparent wind angle. The pilot uses WindTrim to eliminate the effects of turbulence and short term wind variations. This provides smooth precise performance with minimum power consumption.

WindTrim mode uses the fluxgate compass as the primary heading reference. When changes in the apparent wind angle occur, the tiller pilot adjusts the locked compass heading to maintain the original apparent wind angle.

In WindTrim mode, the tiller pilot ignores short-term changes in wind direction, yet still tracks real wind shifts as subtle as 1°.

Selecting WindTrim mode

From Standby mode or Auto mode, press **standby** and **auto** together to select WindTrim. The tiller pilot will then maintain the current apparent wind angle.

Note: The tiller pilot beeps once every 30 seconds in WindTrim mode.

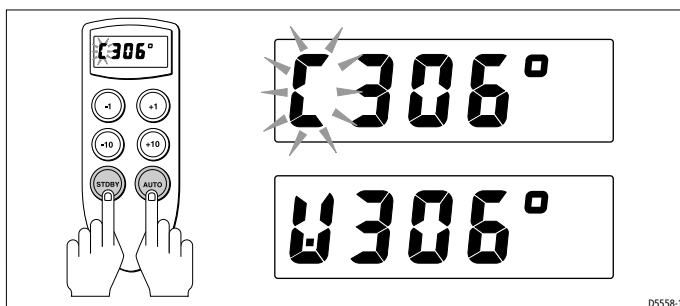

Exiting WindTrim mode

To exit WindTrim mode:

- press **standby** to return to Standby mode
- press **auto** to return to Auto mode

Returning to the previous apparent wind angle

If you have steered the boat away from the selected apparent wind angle (for example, performing a dodge maneuver or selecting Standby) you can return to the previous apparent wind angle:

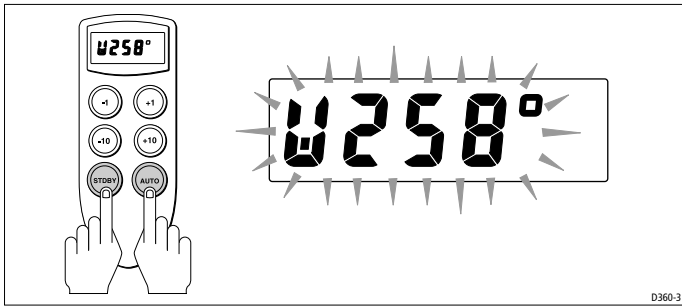

1. Press and hold **standby** and **auto** together for 1 second.
2. The display flashes the previous locked heading for 10 seconds.
3. While the display is flashing, press **standby** and **auto** together to select the previous heading:
 - when you select the previous heading, the “W” flashes for 10 seconds to confirm the selection

Wind shift alarm

If changes in apparent wind angle alter the original locked compass heading by more than 15°, the wind shift alarm will sound.

The display alternates between the current WindTrim heading and the direction of wind shift.

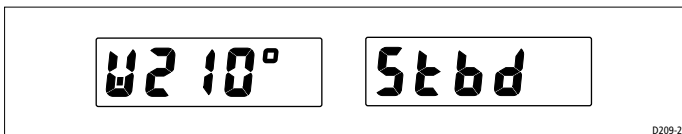

To cancel the wind shift alarm:

- check that the new course does not take the boat into danger
- press **standby** and **auto** together momentarily to accept the alarm and reset the wind shift alarm value to the current compass heading

Operating hints for WindTrim mode

- WindTrim filters the wind vane output. This provides optimum response for offshore conditions where genuine shifts in wind direction occur gradually.
- In gusting and unsteady inshore conditions, it is best to sail a few degrees further off the wind so that changes in apparent wind direction can be tolerated.
- It is important to minimize the amount of standing helm through careful sail trimming and positioning of the mainsheet traveller.
- It is recommended that the headsail and mainsail are reefed a little early rather than too late.

2 Using the Tiller Pilot

Chapter 3: Maintenance & Fault Finding

This chapter provides information about maintaining your tiller pilot system, obtaining product support and solving common problems.

3.1 General maintenance

CAUTION:

The working parts of the tiller drive are sealed and lubricated for life during manufacture. The tiller pilot does not contain any user serviceable parts. It should be repaired only by authorized Raymarine service representatives.

Display condensation

- In certain conditions, condensation may appear on the LCD window. This will not harm the unit, and can be cleared by switching on the illumination for a while.

Routine cabling checks

- Make sure all connections are firmly attached.
- Examine the cable for signs of wear or damage – replace any damaged cables.

Cleaning the tiller pilot

- If the tiller pilot is dirty, wipe it with a clean, damp cloth.
- **Never** use chemical or abrasive materials to clean the tiller pilot.

EMC advice

- When powered up, all electrical equipment produces electromagnetic fields. These can cause adjacent pieces of electrical equipment to interact with one another, with a consequent adverse effect on operation.
- To minimize these effects and enable you to get the best possible performance from your Raymarine equipment, guidelines are given in the installation instructions, to enable you to ensure minimum interaction between different items of equipment, i.e. ensure optimum Electromagnetic Compatibility (EMC).

- Always report any EMC-related problems to your nearest Raymarine dealer. We use such information to improve our quality standards.
- In some installations, it may not be possible to prevent the equipment from being affected by external influences. In general this will not damage the equipment but it can lead to spurious resetting action, or momentarily may result in faulty operation.

3.2 Product support

Raymarine products are supported by a worldwide network of distributors and Authorized Service Representatives.

Before you consider returning the autopilot, make sure that the power supply cable is sound and that all connections are tight and free from corrosion. If the connections are secure, refer to the following Fault Finding section.

If you cannot trace or rectify the fault, contact either your national distributor, service representative, or the **Raymarine Technical Services Call Center**. Refer to the back cover or the Worldwide Distributor List for contact details.

Always quote the product serial number (this number is printed on the underside of the tiller pilot).

3.3 Fault finding

All Raymarine products are designed to provide many years of trouble-free operation. We also put them through comprehensive testing and quality assurance procedures before shipping.

In the unlikely event that a fault does occur with your autopilot, use the following table to help identify the problem and provide a solution. If you cannot resolve the problem yourself, contact either your national distributor, service representative, or the **Raymarine Technical Services Call Center**.

SYMPTOM	SOLUTION
The autopilot display is blank.	No power – check the fuse/circuit breaker.
The displayed compass heading does not agree with the boat's compass.	The compass has not been corrected for deviation – carry out the deviation and alignment procedures (see page 56).
Boat turns slowly and takes a long time to come on to course.	Rudder gain too low (see page 58).
Boat overshoots when turning on to a new course.	Rudder gain too high (see page 58).
The autopilot appears to be unstable on Northerly headings in the Northern hemisphere (or Southerly headings in the Southern hemisphere).	Northerly/Southerly heading correction not set up (see page 65).
Display shows 'CAL OFF' when entering calibration.	Calibration access has been prevented (see page 66).
The autopilot will not 'talk' to other SeaTalk instruments.	Cabling problem – make sure all the cables are connected properly.
Position information not received.	Navigator not transmitting the correct position data.
The autopilot will not auto advance to the next waypoint.	No bearing to waypoint information received from the navigator.
The screen shows a series of rotating dashes.	Compass deviation correction is running.
The display shows a series of stationary dashes.	Data is not being received – check the cabling.
The display shows 'Err'.	The navigator has lost its fix – refer to the navigator handbook for further action.

Part 2: Installing the Tiller Pilot

Part 2: Installing the Tiller Pilot

Chapter 4: Installing the Tiller Pilot

4.1 Planning the installation

Before you start installing your tiller pilot system, use the illustration to check the parts supplied. Then read through the following information and the relevant installation sections in this chapter.

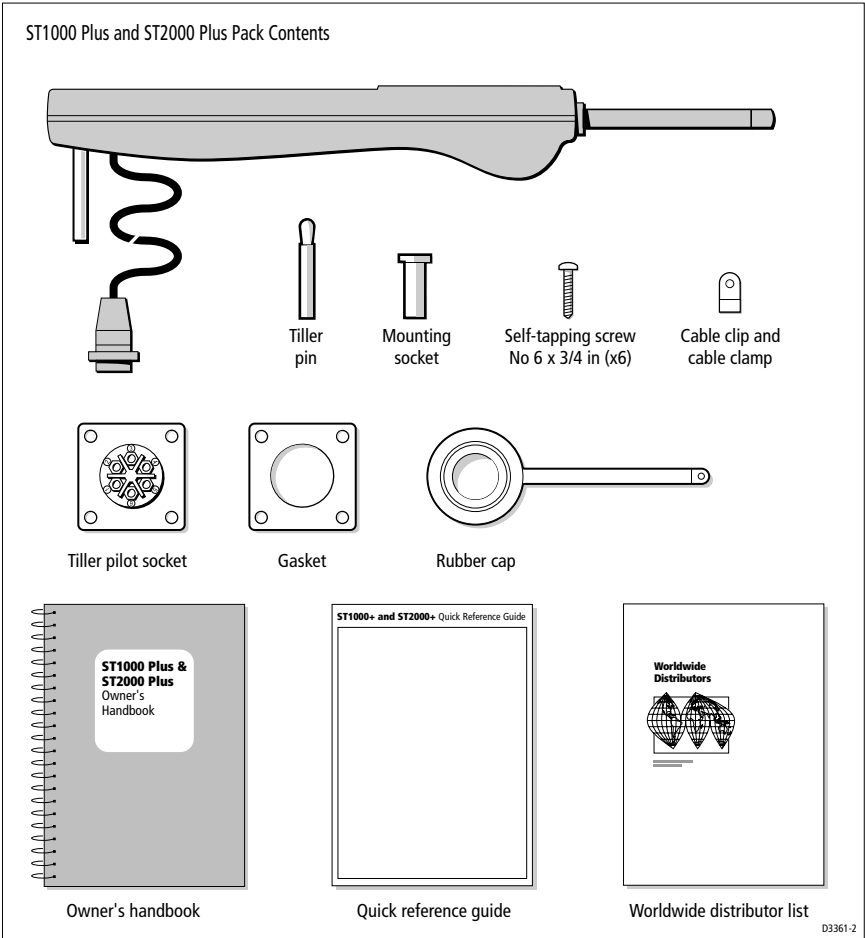

Cabling guidelines

- consider how you will run cables to and from each component
- avoid running cables through bilges where possible
- avoid running cables close to fluorescent lights, engines, radio transmitting equipment etc.

EMC installation guidelines

All Raymarine equipment and accessories are designed to the best industry standards for use in the recreational marine environment.

Their design and manufacture conforms to the appropriate Electromagnetic Compatibility (EMC) standards, but correct installation is required to ensure that performance is not compromised.

Although every effort has been taken to ensure that they will perform under all conditions, it is important to understand what factors could affect the operation of the product.

The guidelines given here describe the conditions for optimum EMC performance, but it is recognized that it may not be possible to meet all of these conditions in all situations.

To ensure the best possible conditions for EMC performance within the constraints imposed by any location, always ensure the maximum separation possible between different items of electrical equipment.

For **optimum** EMC performance, we recommend that:

- Raymarine equipment and cables connected to it are:
 - At least 3 ft (1 m) from any equipment transmitting or cables carrying radio signals e.g. VHF radios, cables and antennas. In the case of SSB radios, increase the distance to 7 ft (2 m).
 - More than 7 ft (2 m) from the path of a radar beam. A radar beam can normally be assumed to spread 20 degrees above and below the radiating element.
- The equipment is supplied from a separate battery from that used for engine start. Voltage drops below 10 V, and starter motor transients, can cause the equipment to reset. This will not damage the equipment, but may cause the loss of some information and may change the operating mode.
- Raymarine specified cables are used. Cutting and rejoining these cables can compromise EMC performance and must be avoided unless doing so is detailed in the installation manual.

- If a suppression ferrite is attached to a cable, this ferrite should not be removed. If the ferrite needs to be removed during installation it must be reassembled in the same position.

EMC suppression ferrites

We supply the fluxgate compass and power cables with suppression ferrites fitted. Always use these ferrites supplied by Raymarine.

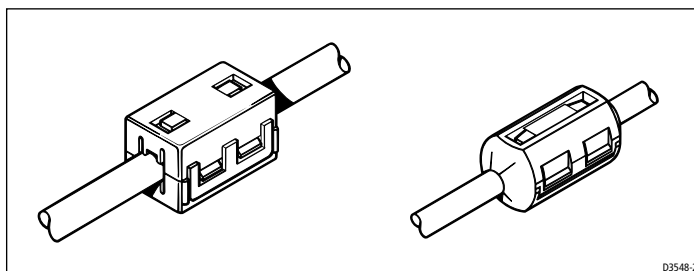

Connections to other equipment

If your Raymarine equipment is to be connected to other equipment using a cable not supplied by Raymarine, a suppression ferrite **MUST** always be attached to the cable near to the Raymarine unit.

4.2 Installing the tiller pin and mounting socket

CAUTION:

As the tiller pilot has a built-in compass, make sure that the boat's steering compass is at least 750 mm (2 ft 6 in) away to avoid deviation.

Measuring the critical dimensions

The tiller pilot is mounted between the tiller and a fixed point on the structure of your boat. Two dimensions are critical to ensure correct installation:

- **Dimension A = 589 mm (23.2 in):** the distance from the mounting socket to the tiller pin

Note: *This dimension increases if your installation requires a pushrod extension (see page 38) or cantilever mount (see page 41).*

- **Dimension B = 460 mm (18 in):** the distance from the rudder stock's center line to the tiller pin

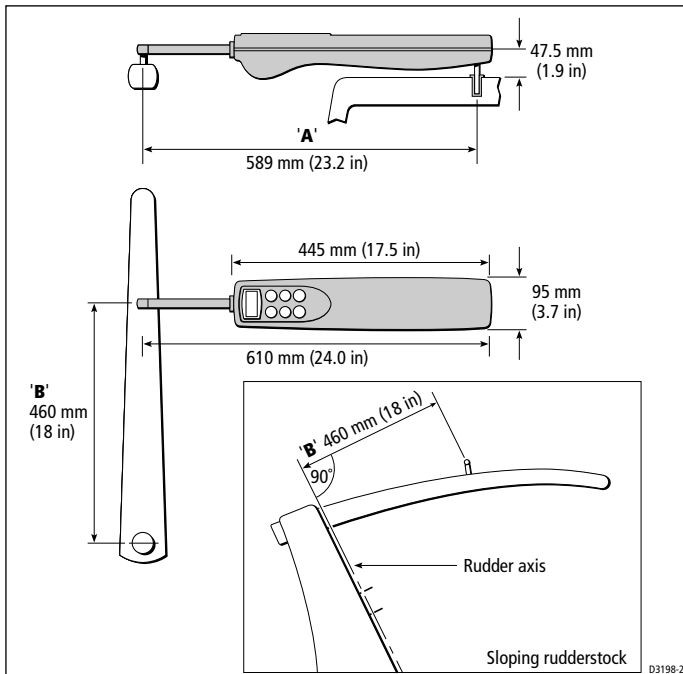

To measure the critical dimensions:

1. Clamp the tiller on the boat's center line.
2. Mark dimensions **A** and **B** and use masking tape to locate the fixing points.

Note: For standard installations, dimension **A** is measured on the starboard side of the cockpit. If you need to mount the tiller pilot on the port side of the cockpit, you can measure dimension **A** to port. However you will need to reverse the tiller pilot's operating sense when you have completed installation (see page 52).

3. Make sure that:
 - dimensions **A** and **B** are at **right angles** to each other (as shown on the diagram opposite)
 - the tiller pilot is mounted **horizontally**

Basic installation

After establishing control dimensions A and B, you can usually mount the tiller pilot directly onto the cockpit seat.

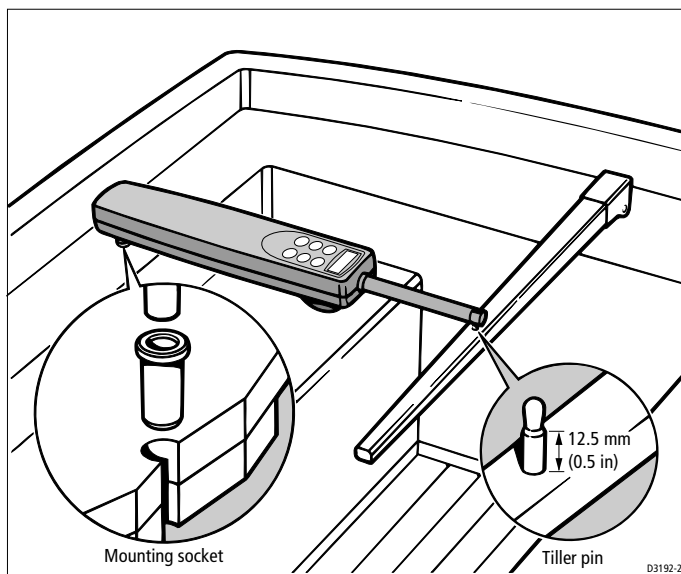

Installing the tiller pin

1. Drill a 6 mm ($\frac{1}{4}$ in) diameter hole to a depth of 25 mm (1 in) at the fixing point you have marked on the tiller.
2. Use a two part epoxy (e.g. Araldite) to fix the tiller pin in place.
3. Position the shoulder of the pin so it is 12.5 mm ($\frac{1}{2}$ in) above the tiller surface.

Installing the mounting socket

1. Drill a 12.5 mm ($\frac{1}{2}$ in) hole to a depth of 25 mm (1 in) at the fixing point you have marked on the cockpit seat.
2. If the structure at the mounting position is less than 25 mm (1 in) thick, reinforce the underside with plywood bonded into position.
3. Fix the mounting socket in place using a two part epoxy.

CAUTION:

As the tiller pilot is capable of generating high pushrod loads, you MUST:

- **drill all holes to the specified size and reinforce where necessary**
- **allow the epoxy to harden thoroughly before applying a load**

Installation accessories

If you are not able to install the tiller pilot directly onto the cockpit seat or tiller as described, one (or a combination) of the following installation accessories:

- pushrod extensions
- tiller brackets
- cantilever sockets
- pedestal sockets
- alternative tiller pins

Pushrod Extensions

If you need to increase the pushrod length (because of the distance from the mounting socket location to the center line), use a Raymarine pushrod extension.

Identifying the correct pushrod extension

1. Clamp the tiller on the boat's center line.
2. Measure dimension C.

3. Select the appropriate pushrod extension length (and part number) using the following table.

Dimension C	Pushrod extension length L	Part no.
589 mm (23.2 in)	Standard dimension	-
615 mm (24.2 in)	25 mm (1 in)	D003
640 mm (25.2 in)	51 mm (2 in)	D004
665 mm (26.2 in)	76 mm (3 in)	D005
691 mm (27.2 in)	102 mm (4 in)	D006
716 mm (28.2 in)	107 mm (5 in)	D007
742 mm (29.2 in)	152 mm (6 in)	D008

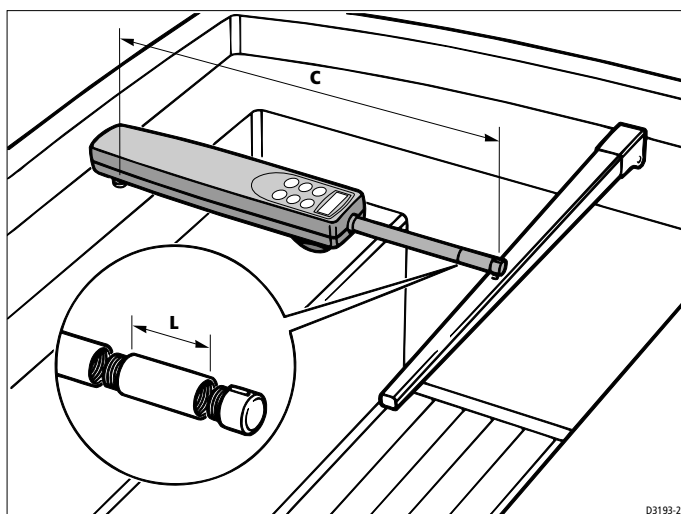

Mounting the pushrod extension

To mount the pushrod extension:

1. Unscrew the end of the tiller pilot's pushrod.
2. Screw the extension into the pushrod.
3. Screw the pushrod end into the pushrod extension.

Tiller brackets

If the tiller is higher or lower than the mounting socket, you can use a Raymarine tiller bracket to vary the tiller pin offset so the pilot is horizontal.

Identifying the correct tiller bracket

1. Clamp the tiller on the boat's center line.
2. Measure dimension **D** (if the pushrod is above the tiller) or dimension **E** (if the pushrod is below the tiller).
3. Select the appropriate bracket from the following table:

Dimension D (pushrod below tiller)	Dimension E (pushrod above tiller)	Bracket part no.
25 mm (1 in)	51 mm (2 in)	D009
51 mm (2 in)	76 mm (3 in)	D010
76 mm (3 in)	102 mm (4 in)	D011
102 mm (4 in)	127 mm (5 in)	D159
127 mm (5 in)	152 mm (6 in)	D160

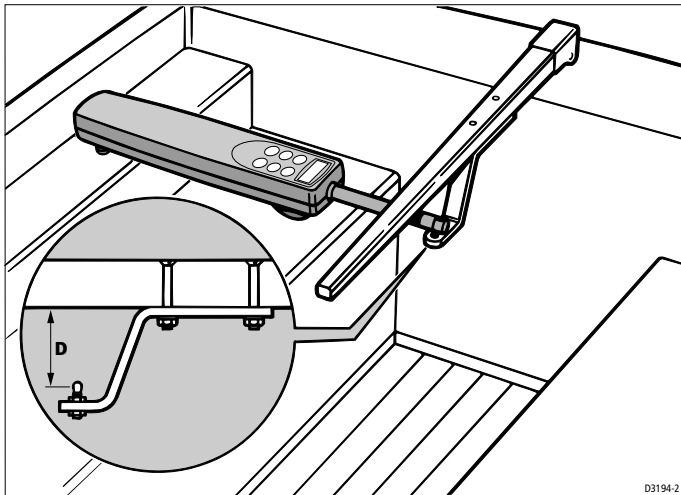

D3194-2

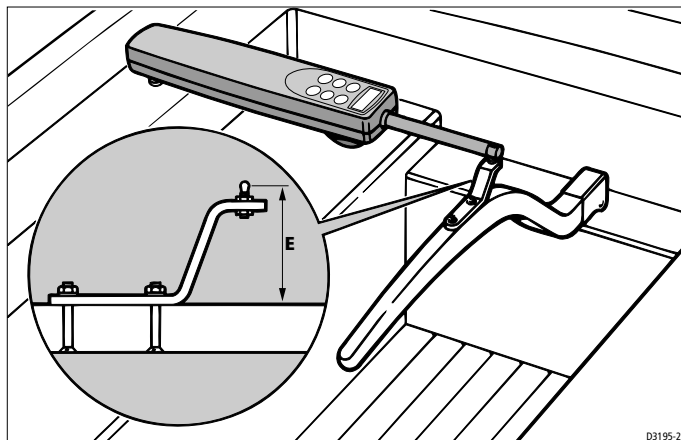

Mounting the tiller bracket

1. Position the tiller bracket on the center line of the tiller (above or below) and establish the critical dimensions **A** and **B**

Note: To measure dimension **B** on a boat with a sloping rudderstock, refer to the diagram on page 36.

2. Mark the centers of the two bracket mounting holes.
3. Drill two 6 mm ($\frac{1}{4}$ in) diameter holes through the center line of the tiller at the positions you have marked.
4. Attach the tiller bracket using two 6 mm ($\frac{1}{4}$ in) diameter bolts, nuts and washers.
5. Bond the fixing bolts in place with two part epoxy adhesive
6. When the epoxy is completely hardened, fully tighten the nuts.
7. Attach the tiller pin to the bracket.

Cantilever mounting

If you need to attach the tiller pilot to a vertical face (such as the cockpit sidewall), use a Raymarine cantilever socket assembly (part number D031):

- the maximum possible extension offset is 254 mm (10 in)
- you cut the cantilever to the exact length during mounting

Cutting the cantilever rod to length

1. Clamp the tiller on the boat's center line.
2. Measure dimension **F** (actual).

3. Refer to the table to establish a cutting length for the cantilever rod – **double check measurements before cutting**.
4. **Measure the rod from threaded end**, then cut the cantilever rod to length **L** using a hacksaw. Remove any sharp edges with a file.

Dimension F	Cut length L
654 mm (25.75 in)	51 mm (2 in)
705 mm (27.75 in)	102 mm (4 in)
743 mm (29.75 in)	152 mm (6 in)
806 mm (31.75 in)	203 mm (8 in)
832 mm (32.75 in)	229 mm (9 in)

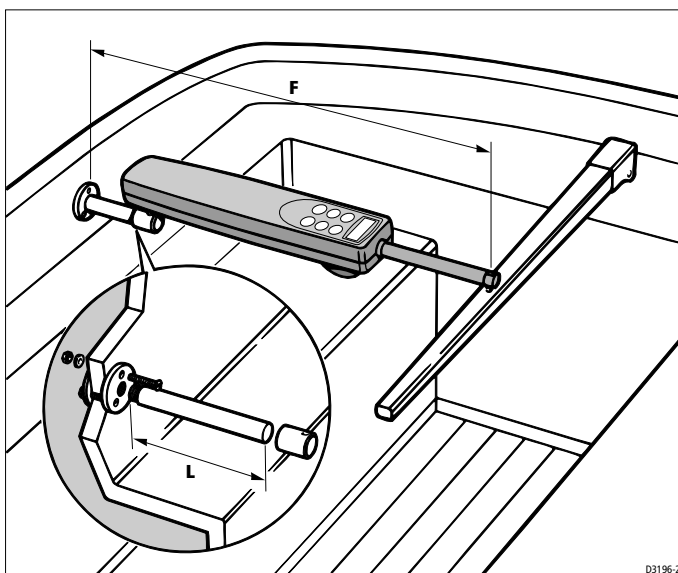

D3196-2

Mounting the cantilever assembly

To mount the cantilever assembly:

1. Temporarily assemble the cantilever by screwing the rod into the mounting ring.
2. Ensure the tiller pilot is **horizontal** and then mark the location of the mounting ring and its mounting holes.
3. Drill three 6 mm ($\frac{1}{4}$ in) diameter holes at the positions you have marked.
4. Bed the mounting ring on a thin coat of silicon sealant.

5. Use three 6 mm ($\frac{1}{4}$ in) diameter bolts, nuts and washers to attach the mounting ring to the backing plate (with the backing plate on the other side of the mounting surface, as shown above).
6. Screw the rod firmly into place.
7. Roughen the end of the cantilever rod and the inside of the cap to provide a key. Then apply two part epoxy adhesive to the rod end and the cap.
8. Place the cap over the rod end, **making sure the hole for the tiller pilot mounting pin faces upwards**. Allow the epoxy adhesive to harden fully before applying a load.

Note: When the tiller pilot is not in use, you can unscrew the complete rod assembly to leave the cockpit unobstructed.

Pedestal socket mounting

If you need to raise the height of the mounting socket to keep the tiller pilot horizontal, use a Raymarine pedestal socket assembly.

Identifying the correct pedestal socket

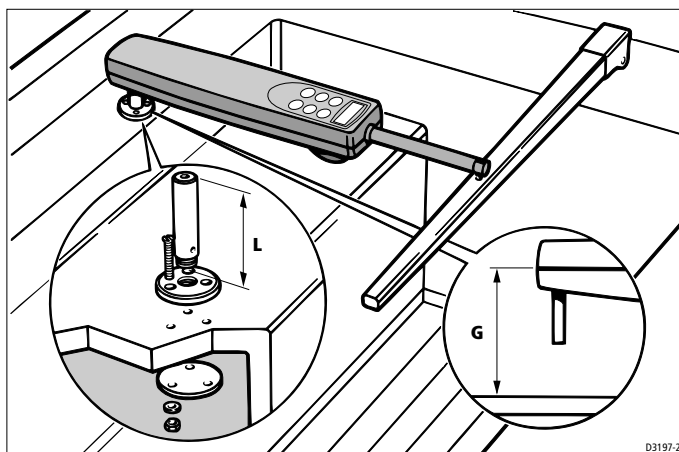

1. Clamp the tiller on the boat's center line.
2. Establish the standard control dimensions **A** and **B**.
3. With the tiller pilot horizontal, measure dimension **G**.
4. Select the appropriate pedestal socket assembly from the table.

Dimension G	Pedestal socket length L	Part no.
64 mm (2.5 in)	Standard dimension	-
102 mm (4.0 in)	38 mm (1.5 in)	D026
114 mm (4.5 in)	50 mm (2.0 in)	D027
127 mm (5.0 in)	64 mm (2.5 in)	D028
140 mm (5.5 in)	76 mm (3.0 in)	D029
153 mm (6.0 in)	89 mm (3.5 in)	D030

Mounting the pedestal socket

1. Mark the mounting ring's position on the cockpit seat or counter.
2. Ensure that control dimensions **A** and **B** are correct.
3. Mark the bolt holes on the mounting ring and then drill three 6 mm ($\frac{1}{4}$ in) diameter holes.
4. Bed the mounting ring on a thin coat of silicon sealant.
5. Use three 6 mm ($\frac{1}{4}$ in) diameter bolts, nuts and washers to attach the mounting ring to the backing plate (with the backing plate on the other side of the mounting surface, as shown above).
6. Screw the mounting socket firmly into place.

Note: *When the tiller pilot is not in use, you can unscrew the complete rod assembly to leave the cockpit unobstructed.*

Alternative tiller pins

Your Raymarine dealer can also supply the following alternative lengths of tiller pin for other non-standard installations.

Description	Size	Part no.
Small threaded tiller pin	25 mm (1.0 in)	D014
Extra length tiller pin	72 mm (2.8 in)	D020
Extra length threaded tiller pin	72 mm (2.8 in)	D021

4.3 Cabling and socket installation

Both power and data are supplied to the tiller pilot via a waterproof plug and socket. The plug comes ready assembled and the socket can be mounted in the cockpit area adjacent to the tiller pilot.

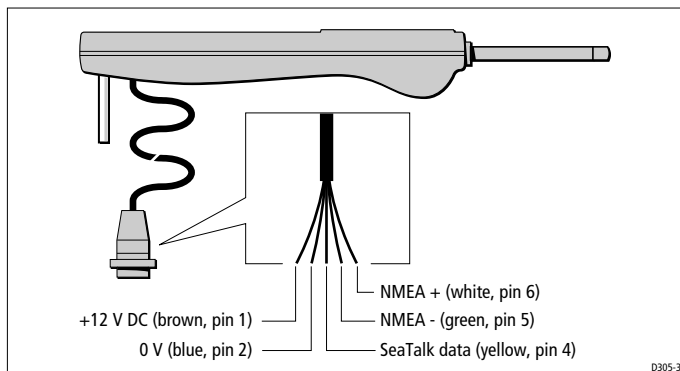

Mounting the socket

Install the tiller pilot socket as follows:

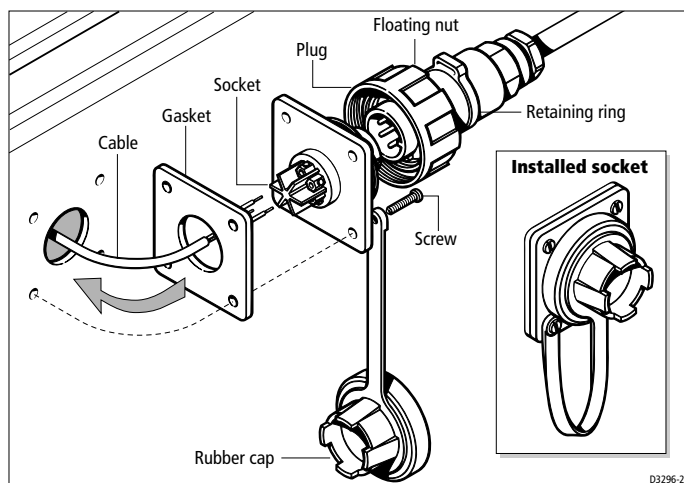

1. Attach the template (provided at the back of this handbook) to the selected bulkhead.
2. Carefully drill a 21 mm ($5^3/64$ in) clearance hole for the cable boss.
3. Drill 4 pilot holes (2.5 mm or $3/32$ in) for the self-tapping screws.

4. Remove the template.
5. Pass the power cable and any other cables (SeaTalk and NMEA) through the bulkhead and the gasket.
6. Use a small flat-bladed screwdriver to connect the cable(s) to the socket – refer to the illustrations on the following pages.

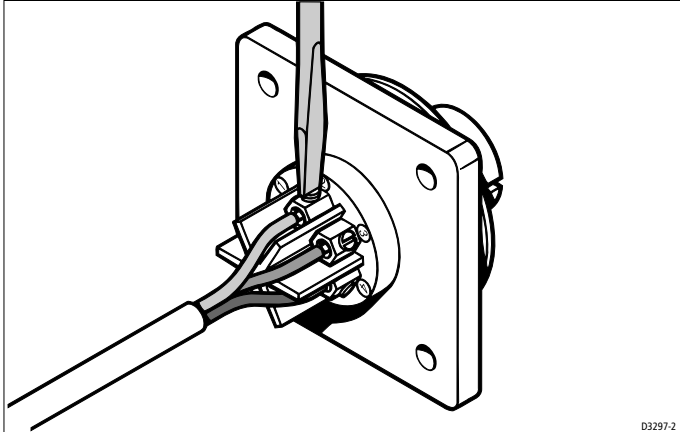

7. Assemble the rubber cap to one of the 4 self-tapping screws.
8. Secure the socket to the bulkhead using the 4 self-tapping screws.
9. Secure the cable(s) at regular intervals using suitable clips.
10. Assemble the plug to the socket by screwing the 'floating' nut onto the threaded part of the socket by hand.
11. The retaining ring is designed as a stop for the plug nut to prevent accidental disassembly. After you have tightened the floating nut, slide the retaining ring back up the plug to retain the nut.

Power supply

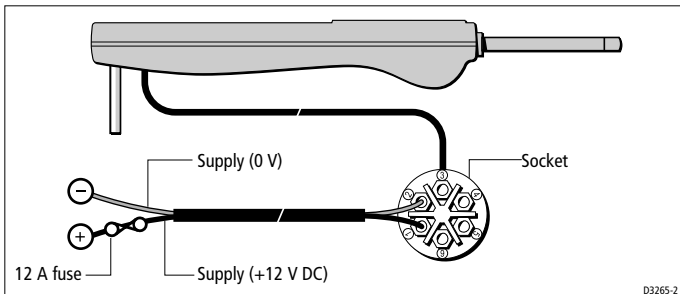

- The tiller pilot requires its own dedicated power supply – it cannot source its power from SeaTalk.
- Power should be taken directly from the boat's central distribution panel and protected with a **12 A fuse** or equivalent circuit breaker.

The following table shows the minimum cable size acceptable for the power supply:

Cable length	Copper area	AWG
Up to 2.5 m (8 ft)	1.5 mm ²	16
Up to 4 m (13 ft)	2.5 mm ²	14

IMPORTANT:

Correct power cable size is critical for correct autopilot operation. If in doubt, use a heavier gauge cable than specified. A lighter gauge cable might cause a voltage drop between the supply and the autopilot. This will reduce the power at the tiller.

SeaTalk cabling

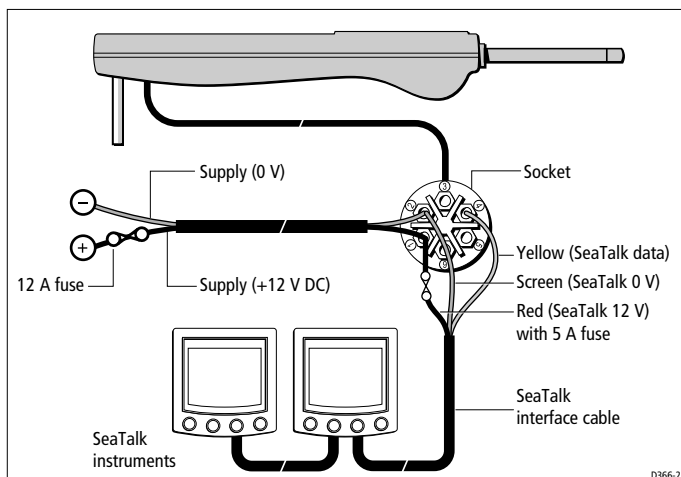

CAUTION:

Protect the power supply for the SeaTalk 12 V (red) line with a 5 A fuse (or equivalent circuit breaker) fitted as close to the tiller pilot as possible.

If required, the tiller pilot can be wired to the SeaTalk bus using a suitable SeaTalk interface cable (part numbers: D229 flat moulded plug, D179 male round plug, D181 female round plug).

Connect the SeaTalk cable to the tiller pilot socket as shown below. As well as sharing SeaTalk data, the tiller pilot can also be used to supply power to the SeaTalk instruments.

Raymarine produce a range of SeaTalk accessory cables you can use to connect the tiller pilot to SeaTalk instruments and control units:

- flat plugs for recent SeaTalk equipment (e.g. ST30, ST40, ST60)
- round plugs for older SeaTalk equipment (e.g. ST50)

Extension cables - flat moulded plugs at each end



Part no.	Type	Length
D284	Flat moulded plugs at each end	1 m (3 ft 3 in)
D285	Flat moulded plugs at each end	3 m (9 ft 10 in)
D286	Flat moulded plugs at each end	5 m (16 ft 5 in)
D287	Flat moulded plugs at each end	9 m (29 ft 6 in)
D288	Flat moulded plugs at each end	20 m (65 ft 6 in)

Conversion cables - flat moulded plug to round plug



Part no.	Type	Length
D187	Flat moulded plug to male round plug	0.15 m (6 in)
D188	Flat moulded plug to female round plug	0.3 m (12 in)

Extension cables - round plugs at each end



Part no.	Type	Length
D124	Male round plug to female round plug	1 m (3 ft 3 in)
D125	Male round plug to female round plug	3 m (9 ft 10 in)
D126	Male round plug to female round plug	6 m (19 ft 8 in)
D154	Male round plug to female round plug	9 m (29 ft 6 in)

Interface cables - flat moulded/round plug to bare ends

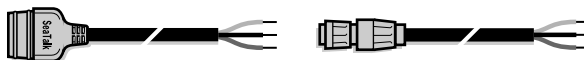

Part no.	Type	Length
D229	Flat moulded plug to bare ends	1 m (3 ft 3 in)
D179	Male round plug to bare ends	3 m (9 ft 10 in)
D181	Female round plug to bare ends	3 m (9 ft 10 in)

D5554-1

Remote control cabling

If required, you can operate the tiller pilot using:

- a full-function ST600R remote control unit (part no: A12016), or
- a SeaTalk hand-held remote control (part no: Z101)

The following illustration shows how to connect a remote control.

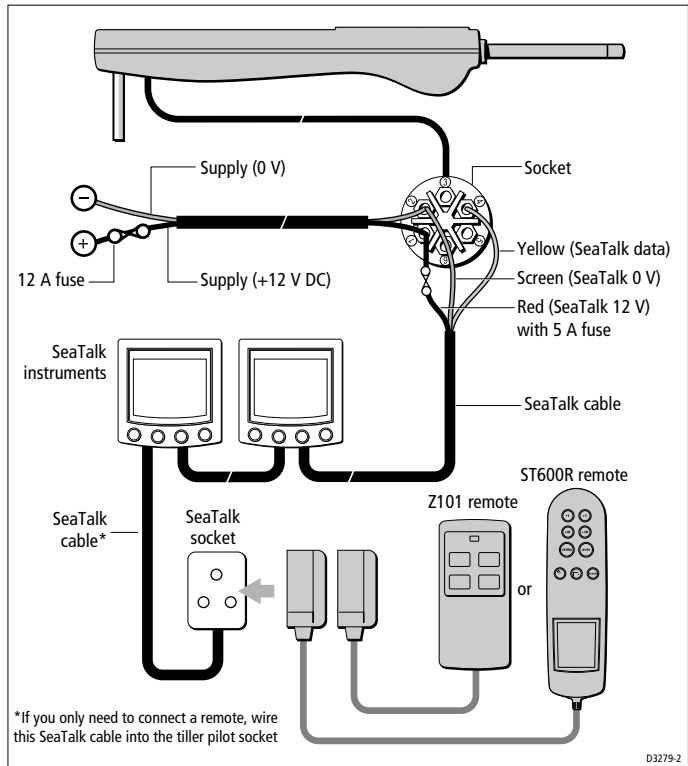

NMEA cabling

If required, you can connect a NMEA navigator or wind instrument to the tiller pilot. It can then use this information for Track and WindTrim modes.

Recognized NMEA data

The following table lists the recognized NMEA sentences.

Information	NMEA 0183 data
Cross Track Error	APB, APA,RMB, XTE, XTR
Bearing to Waypoint	APB, BPI, BWR, BWC, BER, BEC, RMB
Distance to Waypoint	WDR, WDC, BPI, BWR, BWC, BER, BEC, RMB
Waypoint Number	APA, APB,BPI, BWR, WDR, BWC, WDC, RMB, BOD, WCV, BER, BEC
Speed Through Water	VHW
Apparent Wind Angle and Speed	VWR

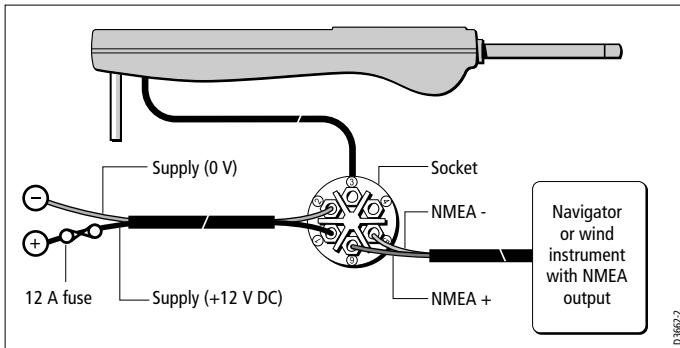

Connecting NMEA and SeaTalk

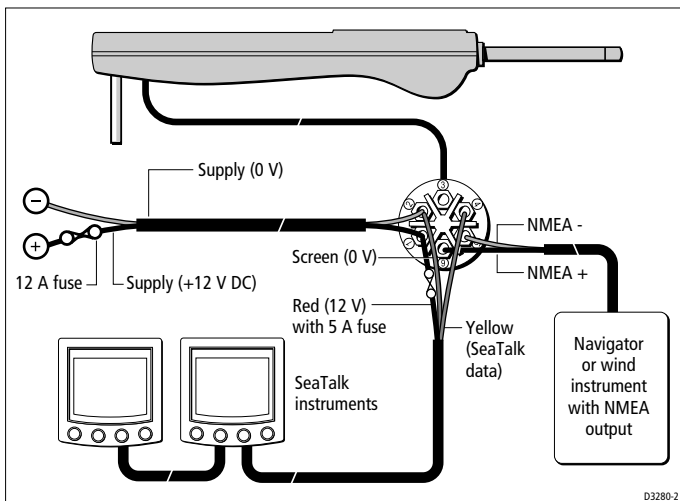

Chapter 5: Commissioning the Tiller Pilot

This chapter explains how to commission your tiller pilot after installation. This consists of a number of simple functional tests followed by a short sea trial.

5.1 Functional tests

Switch on

1. Switch on the main power breaker.
2. The autopilot should beep and display the pilot number (ST1000 or ST2000).
3. Within 2 seconds, the display should show a flashing 'C' followed by the compass heading (for example, C 234). This shows the autopilot is active.

Note: *If the tiller pilot does not beep or display the compass heading, please refer to the Fault Finding section (see page 28).*

Operating sense

The operating sense defines the direction the tiller pilot will apply helm when a course change key is pressed or the boat goes off course. To check the operating sense:

1. Place the pushrod end over the tiller pin.
2. Press **+10**.
3. The helm should move to produce a turn to starboard.

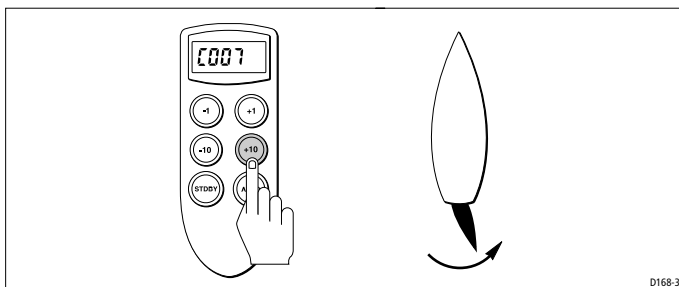

4. If the helm produces a turn to port, refer to the following instructions on reversing the operating sense.

Reversing the operating sense

If necessary, reverse the operating sense can be reversed as follows:

1. Press **-1** and **+1** together for 5 seconds.
2. The display shows the new operating sense (port or starboard) for 5 seconds, and then the autopilot reverts to normal operation.

Checking the navigation interface

If you have connected the tiller pilot to a navigator, check the interface as follows:

1. Set up a track on the navigator to give a Cross Track Error between 0 nm and 0.3 nm.
2. Enter Auto mode by pressing **auto**.
3. Enter Track mode by pressing **-10** and **+10** together.
4. An alarm will sound and the display will alternate between the bearing to waypoint and the direction the boat will turn to acquire it.

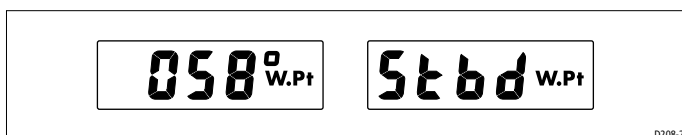

5. Make sure that it is safe to turn onto the new course, then press **-10** and **+10** again.
6. If the navigator is connected correctly, the display will begin to cycle through the available navigation data:

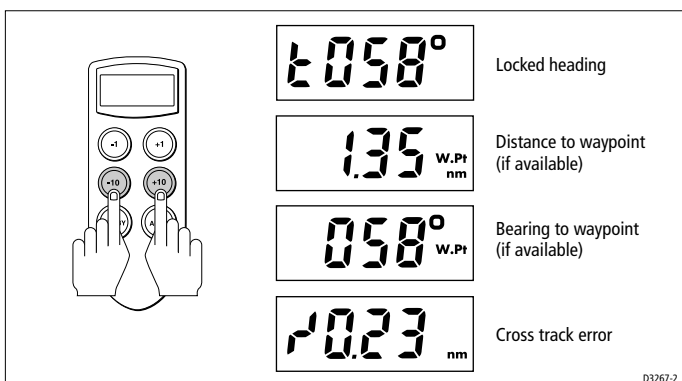

Navigation error screens

If the display shows either of the following error displays, the cause is either:

- a wiring error, or
- the navigator is not configured to transmit the required data format

Track data not received

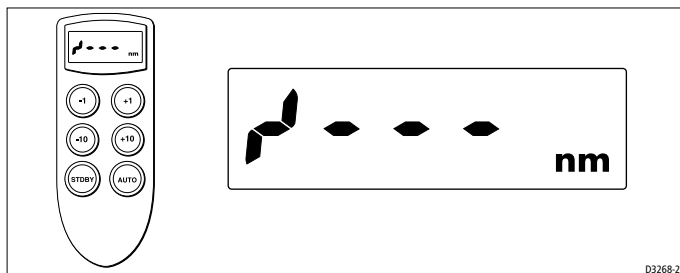

This error message indicates that data has not been received. The most likely reason is a cabling error – either open circuit, short circuit or wires reversed.

Track data error

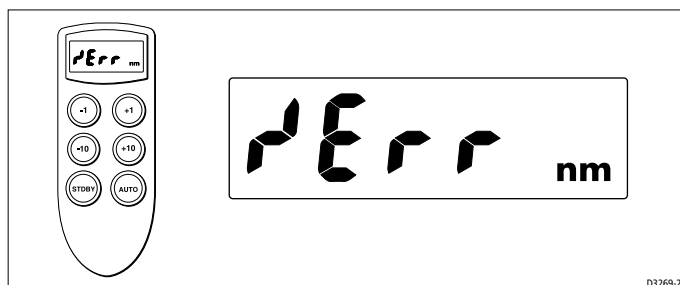

This error message indicates that the navigator has lost its fix. Refer to the navigator handbook for further action.

Checking the wind instrument interface

If you have connected the tiller pilot to a wind instrument, check the data link as follows:

1. Press **standby** and **auto** together.
2. The tiller pilot should display a 'W' followed by the locked heading.

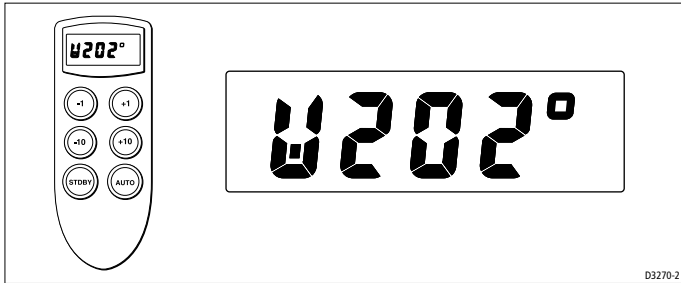

If the display continues to show a flashing 'C' and the current heading, the tiller pilot is not receiving any wind data. The most likely reason is a cabling error – either open circuit, short circuit or wires reversed.

Checking the SeaTalk interface

If you have linked the tiller pilot to other instruments or control units via SeaTalk, check the link as follows:

1. Press **standby**.

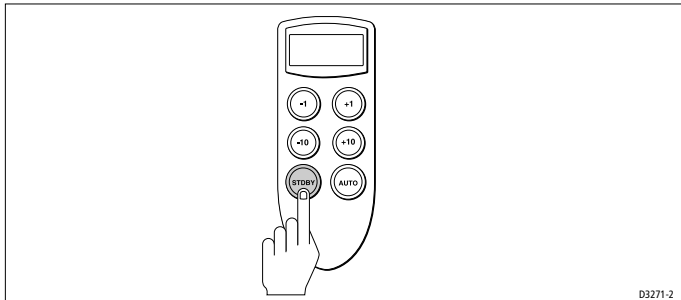

2. Select display illumination level 0 (LAMP 0) on any other SeaTalk instrument or autopilot control unit.

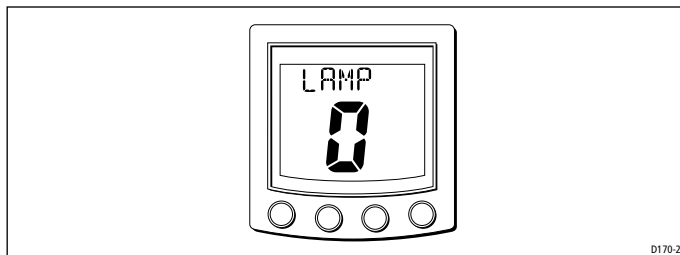

3. The tiller pilot should immediately respond by switching off its display illumination. If the illumination does not switch off, there is a cabling fault between the tiller pilot and the instruments or control unit.

5.2 Initial sea trial

CAUTION:

Failure to carry out the sea trial may result in impaired autopilot performance on some compass headings.

When you have checked that the system is operating correctly, you must complete a short sea trial to calibrate the compass.

The tiller pilot has a built-in calibration capability so you can fine-tune it to suit your boat, its steering system and its dynamic steering characteristics.

As supplied from the factory, the autopilot is calibrated to provide safe, stable control for most boats.

- Do not attempt to make any permanent changes to the recommended calibration values until you have completed the sea trial.
- You **must** carry out the initial sea trial in conditions of light wind and calm water – so you can assess the autopilot's performance without the influence of strong winds or large waves.

Before starting the sea trial

Before carrying out the sea trial, you should:

- check the calibration settings and, if necessary, reset them to the default values (see *page 63*)
- check the installation to make sure that it is not affected by radio transmissions, engine starting, etc.

Calibrating the compass

Automatic compass deviation correction

By completing the following compass correction procedure, the tiller pilot can correct its own internal fluxgate compass for most deviating magnetic fields. **You should complete the Compass Deviation Correction at the beginning of your sea trial.**

To complete the compass correction:

1. Extend or retract the pushrod so you can place the pushrod end onto the tiller pin.
2. Press and hold **standby** for 1 second – a series of dashes will cycle around the display.

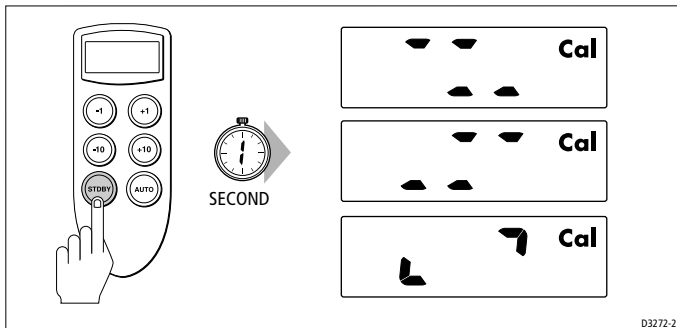

3. Keeping boat speed below 2 knots, use the **-10** and **+10** keys to turn the boat in slow circles. You should take at least 3 minutes to complete each 360°.

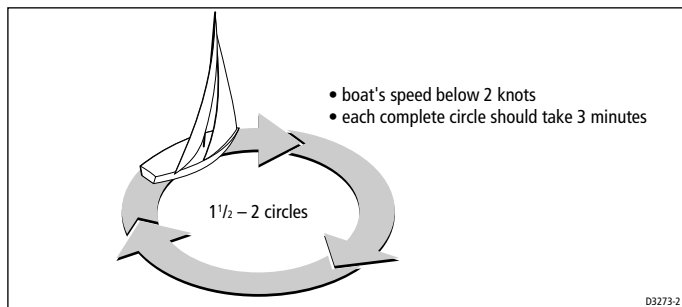

4. Keep turning your boat until the display changes to show the amount of deviation the autopilot has detected (this should take between $1\frac{1}{2}$ to 2 complete circles). The deviation alternates with the autopilot's current heading every second.

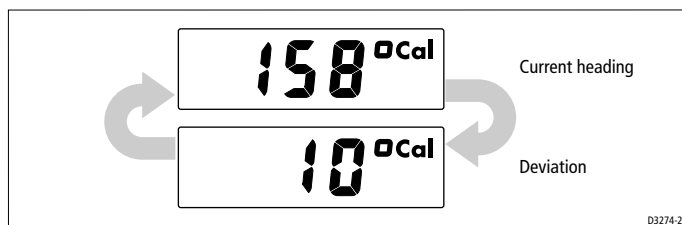

Heading alignment

1. Use the **-1** and **+1** keys to increase or decrease the displayed heading until it agrees with the heading on the boat's steering compass, or a known transit bearing.
2. Exit compass linearization and heading alignment and store the compass correction/alignment values as follows:
 - press and hold **standby** for 1 second until the pilot beeps
 - or, to exit without saving any new settings, press **standby** momentarily

Note: For installations where an ST50 or ST30 Steering Compass instrument is connected to the SeaTalk bus, **and** the Steering Compass has a fluxgate transducer connected, it is only necessary to carry out the auto deviation correction on the Steering Compass Instrument (refer to Steering Compass handbook instructions).

Further adjustments to heading alignment

If the heading alignment requires further adjustment, enter Compass Deviation Correction again by pressing **standby** for 1 second.

1. Press **auto** to skip Deviation Correction and proceed to Heading Alignment.
2. Adjust the heading as described above.

Autopilot operation

Having calibrated the compass, the following procedure is recommended to familiarize yourself with autopilot operation:

1. Steer onto a compass heading and hold the course steady.
2. Place the pushrod end over the tiller pin.
3. Press **auto** to lock onto the current heading. The tiller pilot should achieve a constant heading in calm sea conditions.
4. Alter course to port or starboard in multiples of 1° and 10° .

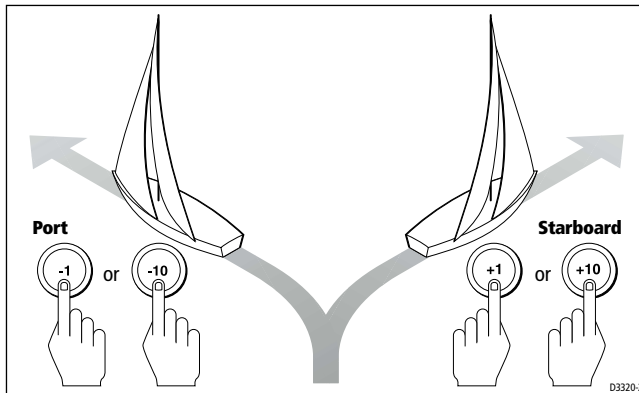

5. Press **standby** and remove the pilot to return to hand steering.

5.3 Adjusting autopilot performance

The factory setting for rudder gain provides stable control for initial sea trials. However, different boats can vary widely in their response to the helm and further adjustment to the rudder gain may improve the autopilot's steering characteristics.

The following test will determine whether the rudder gain is set too high or too low.

1. In clear water and with the autopilot in Auto mode, alter course to starboard by 40° by pressing **+10** four times.
 - At cruising speeds, a course change of 40° should result in a crisp turn followed by an overshoot of no more than 5° .
If this occurs the rudder gain is set correctly.
 - If rudder gain is too high, the 40° course change will result in a distinct overshoot of more than 5° (A).
Correct this oversteer by reducing the rudder gain setting.
 - If rudder gain is too low, the boat's steering performance will be sluggish – it will take a long time to make the 40° turn and there will be no overshoot (B).
Correct this understeer by increasing the rudder gain setting.

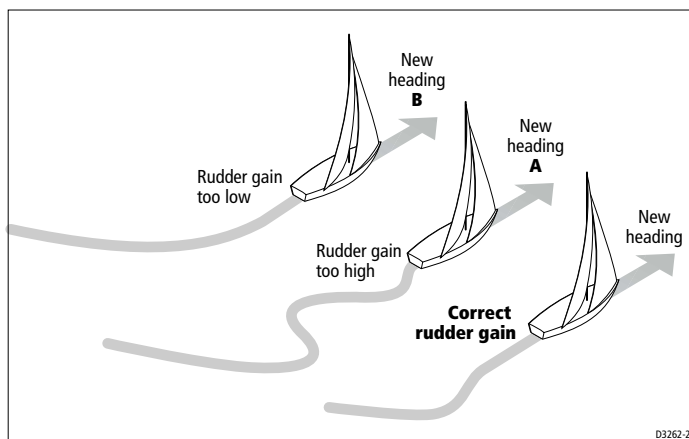

Note: It is easier to recognize these actions in calm sea conditions where wave action does not mask basic steering performance.

2. Refer to the calibration menu diagram in *Chapter 6: Adjusting Tiller Pilot Settings*, for instructions on how to adjust the rudder gain setting.
3. Repeat the test until you achieve crisp course changes with no more than 5° of overshoot.

You should set the rudder gain to the lowest setting consistent with accurate course keeping. This will minimize drive movements and reduce power consumption and wear and tear.

Chapter 6: Adjusting Tiller Pilot Settings

6.1 Introduction

The tiller pilot is calibrated at the factory to provide stable performance for most boats. However, you can fine tune many of the calibration features to match your personal preferences, and the type of boat and steering system.

Note: *You should carry out an initial sea trial **before** adjusting any of the calibration features.*

You might need to adjust the tiller pilot calibration settings if:

- the pilot does not maintain a selected heading
- the rudder activity is too high or the course keeping is not tight enough.
- the boat appears to be unstable on Northerly headings (or Southerly headings in the southern hemisphere)
- you operate in Track Control mode without a speed instrument
- you wish to change the Off Course alarm angle

The calibration menu allows you to adjust the following parameters from their factory default settings:

- rudder gain
- average cruise speed
- off course alarm limit
- variation
- Northerly/Southerly turning error compensation
- boat's current latitude
- rudder damping

Adjusting calibration values

The flow chart on the next page shows how to:

- enter the calibration menu
- scroll through the calibration menu
- adjust the calibration values
- quit calibration

Calibration menu



SECONDS



REPEAT THE ABOVE KEYPRESS
WITHIN 10 SECONDS TO ENTER CALIBRATION



SECONDS

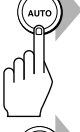
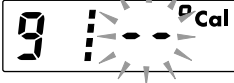
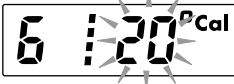

Does not appear if Level 10 is set to 0.



- 1 = Rudder gain
- 5 = Average cruise speed
- 6 = Off course alarm angle
- 9 = Local magnetic variation
- 10 = Northerly/Southerly turning error correction
- 11 = Current boat latitude
- 13 = Rudder damping

ADJUSTING CALIBRATION FEATURES

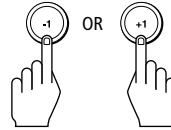

QUITTING CALIBRATION AND SAVING ANY CHANGES

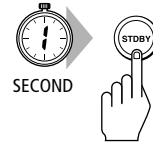

QUITTING CALIBRATION WITHOUT SAVING CHANGES



Calibration features

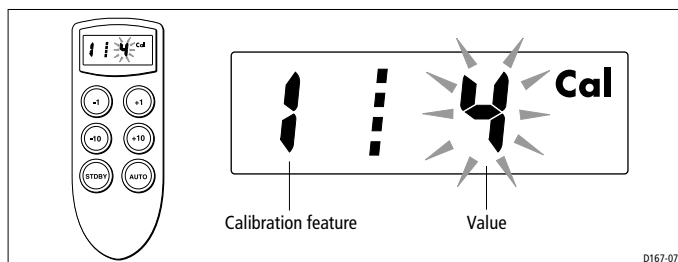

- The number on the left identifies the calibration feature and the number on the right the currently selected value.
- You can enter the calibration menu to view the existing values without altering them. After viewing the value, a momentary press of **standby** returns the pilot to its normal operating mode without affecting the previous settings.
- If the display shows CAL OFF when you try to enter calibration, refer to *page 66*.

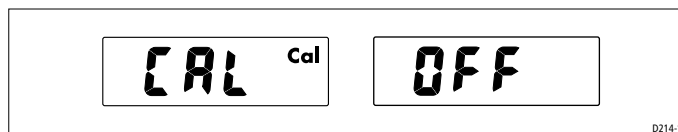

Default calibration values

The following table shows the default calibration values. These will provide safe performance for initial sea trial.

No.	Feature	Default setting	Adjusted values
1	Rudder gain	5	
5	Average cruise speed	8	
6	Off course alarm angle	20	
9	Local magnetic variation	Off (—)	
10	North/South turning error correction	Off (0)	
11	Boat's current latitude	0	
13	Rudder damping	3	

Note: Calibration Levels 2,3,4,7,8 and 12 are not available. If Calibration Level 10 is set to 0, level 11 will also be omitted.

6.2 Calibrating the tiller pilot

Calibration Level 1: Rudder gain

Use Calibration Level 1 to adjust the rudder gain. This must be set when your boat is under way, as described on *page 58*.

Calibration Level 5: cruise speed

Use Calibration Level 5 to set the boat's normal cruising speed for operation in Track mode.

When interfacing with a navigation system, the tiller pilot uses the boat's average cruising speed to perform track calculations.

Note: *If a SeaTalk speed instrument is connected, boat speed data will be transmitted directly to the autopilot.*

Calibration Level 6: off course alarm angle

Use Calibration Level 6 to set the off course alarm angle. This alarm warns you if the autopilot is unable to maintain its set course.

The off course alarm operates if the autopilot strays off course, by more than the set value, for more than 20 seconds.

You can set the limit in 1° increments between 15° and 40°.

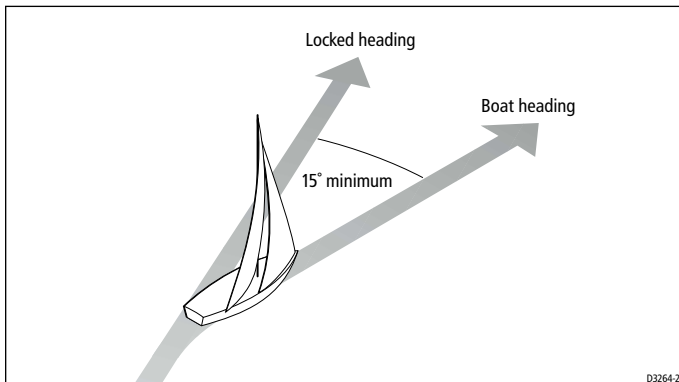

Calibration Level 9: magnetic variation

Use Calibration Level 9 to input the level of magnetic variation present at the boat's current position.

- -ve variation = west
- +ve variation = east

The tiller pilot transmits this value onto the SeaTalk bus, so it can be picked up by other SeaTalk instruments.

Calibration Level 10: heading error correction

Use Calibration Level 10 to switch on Northerly or Southerly heading error correction:

- 0 = Off
- 1 = Northern Hemisphere, 2 = Southern Hemisphere

You might notice that the autopilot tends to be a little less stable on Northerly headings in the higher latitudes of the Northern hemisphere (or Southerly headings in the Southern hemisphere).

This is caused by the increasing angle of dip of the earth's magnetic field at higher latitudes, which has the effect of amplifying rudder response on Northerly (Southerly) headings. This error affects all magnetic compasses and gets worse further away from the equator.

With heading error correction switched on, the tiller pilot can compensate for this error by automatically adjusting the autopilot gain (depending on heading). This will provide precise course keeping on all headings.

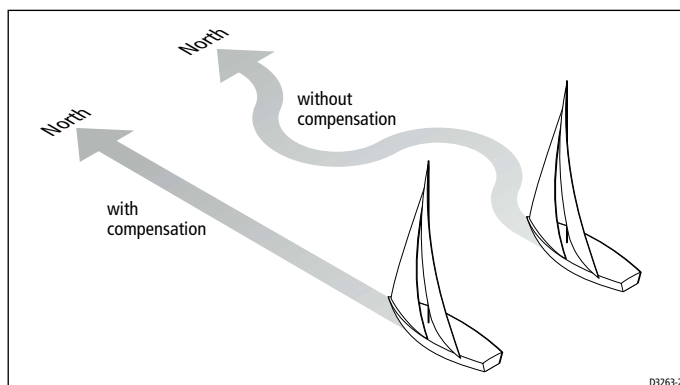

Calibration Level 11: boat's current latitude

When you have switched on heading error correction (Level 10), you need to use Calibration Level 11 to input the boat's current latitude (to the nearest degree).

Set the latitude using the **-1**, **+1**, **-10** and **+10** keys.

Note: *If the correction is switched off in Calibration Level 10 (i.e. set to '0'), Level 11 will be omitted. When you press the **auto** key in Calibration Level 10 you will advance to Level 13.*

Calibration Level 13: rudder damping

Adjust the value in Calibration Level 13 if the tiller drive 'hunts' when trying to position the rudder.

- you can select 9 stages of rudder damping – initially, this option should be set to 3
- if the autopilot is over-active in calm conditions, increase the damping
- if the course keeping is not tight enough, decrease the damping
- adjust the damping one stage at a time

Controlling access to calibration

You can prevent unauthorized access to calibration as follows:

1. Press and hold **-1** and **standby** together for 10 seconds until the display shows CAL OFF:

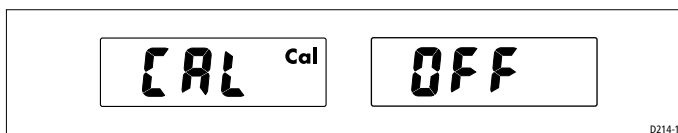

2. Toggle the calibration access between On and OFF using the **-1** and **+1** keys.
3. Store the setting by pressing **-1** and **standby** for 10 seconds until the tiller drive returns to normal operation.

**ST1000+ and ST2000+
tiller drives: socket template**

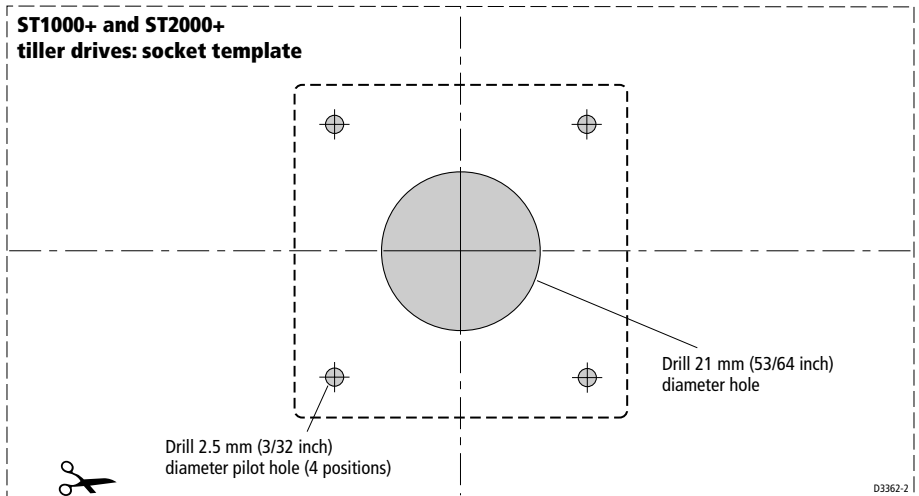

Index

A

- Adjusting autopilot performance 58
- Adjusting tiller pilot settings 61–66
- Alarms and warnings
 - Large XTE 17, 21
 - Off course alarm 11
 - Track data error 21
 - Track data not received 21
 - Waypoint advance 19, 22
 - Wind shift 24
- Auto mode 8–14
 - Automatic deadband 12
 - AutoTack 10
 - Changing course 9
 - Dodging obstacles 10
 - Entering Auto mode 8
 - Exiting Auto mode 8
 - Navigation information pages 12
 - Off course alarm 11
 - Return to previous heading 11
- Auto Seastate 12
- Automatic deviation correction 56

B

- Boat's current latitude 66

C

- Cabling
 - NMEA 49
 - Power 47
 - Remote control (optional) 49
 - SeaTalk 47
- Calibration 61–66
 - Access 66
 - Default values 63
 - Level 01 - Rudder gain 58, 64
 - Level 05 - Cruise speed 64
 - Level 06 - Off course alarm angle 64
 - Level 09 - Magnetic variation 65
 - Level 10 - Heading error 65
 - Level 11 - Boat's current latitude 66
 - Level 13 - Rudder damping 66

- Cantilever mounting 41
- Changing course 9, 13
- Commissioning the tiller pilot 51–59
 - Adjusting rudder gain 58
 - Functional tests 51–55
 - Initial sea trial 55–58
- Compass calibration 56–58
 - Deviation correction 56
 - Heading alignment 57
- Cross track error 17
- Cruise speed 64
- Current latitude 66

D

- Display illumination 14
- Dodging obstacles 10, 19

E

- EMC
 - Installation guidelines 34
 - Servicing and safety guidelines 27

F

- Fault finding 28
- Functional test
 - Navigation interface 52
 - Operating sense 51
 - SeaTalk interface 54
 - Switch on 51
 - Wind instrument interface 54

H

- Heading alignment 57
- Heading error correction 65

I

- Illumination 14
- Initial sea trial
 - Checking autopilot operation 58
 - Compass deviation correction 56
 - Heading alignment 57
- Installation 33–50

- Cabling
 - NMEA 49
 - Power 47
 - SeaTalk 47
- EMC guidelines 34
- Parts supplied 33
- Socket 45
- Tiller drive 36–44

L

- Lighting 14

M

- Magnetic variation 65
- Maintenance 27
- Mounting socket 38

N

- Navigation information pages 12
- NMEA
 - Cabling 49
 - Recognized data 49
- Northerly heading error correction 65

O

- Off course alarm 11
- Off course alarm angle 64
- Operating modes 7–25
 - Auto mode 8–14
 - Track mode 15–22
 - WindTrim mode 23–25
- Operating sense, reversing 52

P

- Parts supplied 33
- Pedestal socket mounting 43
- Power
 - Cabling 47
 - Socket installation 45
- Product support 28
- Pushrod extensions 38

R

- Recognized NMEA data 49
- Remote control cabling 49

- Return to previous heading 11
- Rudder damping 66
- Rudder gain 58, 64

S

- SeaTalk
 - Accessory cables 48
 - Cabling 47
- Servicing 27
- Socket installation 45
- Southerly heading error correction 65
- Specifications 2

T

- Tiller drive installation 36–44
 - Cantilever mounting 41
 - Mounting socket 38
 - Pedestal socket mounting 43
 - Pushrod extensions 38
 - Tiller brackets 40
 - Tiller pin 38
 - Tiller pin (Non-standard) 44
- Track mode 15–22
 - Cross track error 17
 - Dodging obstacles 19
 - Entering Track mode 15
 - Automatic acquisition 15
 - Manual acquisition 16
 - Exiting Track mode 17
 - Safety 20
 - Tidal stream compensation 18
 - Warning messages 21
 - Waypoint arrival/advance 19

W

- WindTrim mode 23–25
 - Entering WindTrim mode 23
 - Exiting WindTrim mode 24
 - Return to previous wind 24
 - Wind shift alarm 24

X

- XTE (Cross track error) 17

Limited Warranty Certificate

Raymarine warrants each new Light Marine/Dealer Distributor Product to be of good materials and workmanship, and will repair or exchange any parts proven to be defective in material and workmanship under normal use for a period of 2 years/24 months from date of sale to end user, except as provided below.

Defects will be corrected by Raymarine or an authorized Raymarine dealer. Raymarine will, except as provided below, accept labor cost for a period of 2 years/24 months from the date of sale to end user. During this period, except for certain products, travel costs (auto mileage and tolls) up to 100 round trip highway miles (160 kilometres) and travel time of 2 hours, will be assumed by Raymarine only on products where proof of installation or commission by authorized service agents, can be shown.

Warranty Limitations

Raymarine Warranty policy does not apply to equipment which has been subjected to accident, abuse or misuse, shipping damage, alterations, corrosion, incorrect and/or non-authorized service, or equipment on which the serial number has been altered, mutilated or removed.

Except where Raymarine or its authorized dealer has performed the installation, it assumes no responsibility for damage incurred during installation.

This Warranty does not cover routine system checkouts or alignment/calibration, unless required by replacement of part(s) in the area being aligned.

A suitable proof of purchase, showing date, place, and serial number must be made available to Raymarine or authorized service agent at the time of request for Warranty service.

Consumable items, (such as: Chart paper, lamps, fuses, batteries, styli, stylus/drive belts, radar mixer crystals/diodes, snap-in impeller carriers, impellers, impeller bearings, and impeller shaft) are specifically excluded from this Warranty.

Magnetrons, Cathode Ray Tubes (CRT), TFT Liquid Crystal Displays (LCD) and cold cathode fluorescent lamps (CCFL), hailer horns and transducers are warranted for 1 year/12 months from date of sale. These items must be returned to a Raymarine facility.

All costs associated with transducer replacement, other than the cost of the transducer itself, are specifically excluded from this Warranty.

Overtime premium labor portion of services outside of normal working hours is not covered by this Warranty.

Travel cost allowance on certain products with a suggested retail price below \$2500.00 is not authorized. When/or if repairs are necessary, these products must be forwarded to a Raymarine facility or an authorized dealer at owner's expense will be returned via surface carrier at no cost to the owner.

Travel costs other than auto mileage, tolls and two (2) hours travel time, are specifically excluded on all products. Travel costs which are excluded from the coverage of this Warranty include but are not limited to: taxi, launch fees, aircraft rental, subsistence, customs, shipping and communication charges etc. Travel costs, mileage and time, in excess to that allowed must have prior approval in writing.

TO THE EXTENT CONSISTENT WITH STATE AND FEDERAL LAW:

(1) THIS WARRANTY IS STRICTLY LIMITED TO THE TERMS INDICATED HEREIN, AND NO OTHER WARRANTIES OR REMEDIES SHALL BE BINDING ON RAYMARINE INCLUDING WITHOUT LIMITATION ANY WARRANTIES OF MERCHANTABILITY OR FITNESS FOR A PARTICULAR PURPOSE.

(2) Raymarine shall not be liable for any incidental, consequential or special (including punitive or multiple) damages.

All Raymarine products sold or provided hereunder are merely aids to navigation. It is the responsibility of the user to exercise discretion and proper navigational skill independent of any Raymarine equipment.

Raymarine

Factory Service Centers

United States of America

Raymarine Inc
22 Cotton Road, Unit D
Nashua, NH 03063-4219, USA

Telephone: +1 603 881 5200
Fax: +1 603 864 4756
www.raymarine.com

Sales & Order Services

Telephone: +1 800 539 5539 Ext. 2333 or
+1 603 881 5200 Ext. 2333

Technical Support

Telephone: +1 800 539 5539 Ext. 2444 or
+1 603 881 5200 Ext. 2444
Email: techsupport@raymarine.com

Product Repair Center

Telephone: +1 800 539 5539 Ext. 2118

UK, Europe, Middle East, Far East

Raymarine Ltd
Anchorage Park, Portsmouth
PO3 5TD, England

Telephone: +44 (0)23 9269 3611
Fax: +44 (0)23 9269 4642
www.raymarine.com

Customer Support

Telephone: +44 (0)23 9271 4713
Fax: +44 (0)23 9266 1228

Email: techsupport@raymarine.com

Stick barcode label here

Purchased from

Purchase date

Dealer address

Installed by

Installation date

Commissioned by

Commissioning date

Owner's name

Mailing address

This portion should be completed and retained by the owner.