

## QK-A033

### WiFi/USB/NMEA 0183 Multiplexer

Bi-directional routing and filtering

With SeaTalk Converter



Designed in UK



## Features

- Multiplex up to three NMEA 0183 input devices
- Configurable baud rates (4800, 9600, 38400bps)
- Simultaneous WiFi, USB and NMEA output
- Galvanically isolated NMEA and SeaTalk input ports
- Differential NMEA output with galvanically isolated protection
- Bi-directional USB/WiFi interface enables connection between navigation devices and Autopilot
- WiFi – Ad-hoc mode allows up to 4 devices to connect to the internal WiFi module simultaneously
- WiFi – Station mode allows for the connection of the A033 to your router/ access point for greater number of wireless users and WiFi range.
- SeaTalk to NMEA 0183 protocol converter
- Wide range of power supply voltage tolerance (DC 9-35 Volts)
- Compatible with Windows, Mac, Linux,
- Compatible with Android and iOS excluding Configuration and USB functions. (Please note Configuration must be completed using Windows software.)
- Advanced filtering and routing functions allows for full overflow reduction and additional configuration of the multiplexer.
- Monitoring of NMEA data passing through the device.

## Contents

1.	Introduction.....	3
2.	Mounting.....	4
3.	Connections.....	5
3.1.	SeaTalk <sup>1</sup> .....	6
3.2.	NMEA Inputs and Outputs.....	7
3.2.1.	NMEA Inputs.....	7
3.2.2.	NMEA Outputs.....	7
3.2.3.	Addition Functions.....	7
4.	Wireless Connections.....	9
4.1.	WiFi Ad-hoc mode.....	9
5.	Connecting via USB port.....	10
5.1.	Will a driver needed to connect via USB?.....	10
5.2.	Bi-directional USB.....	10
5.3.	Checking the USB connection (Windows).....	10
6.	Status LED's.....	11
7.	Configuration.....	12
7.1.	Configuring Baud Rates.....	13
7.2.	WiFi - Station mode.....	14
7.3.	WiFi - Standby.....	14
7.4.	Configuring Routing and Filtering.....	15
7.4.1.	Filtering: Black list setup.....	15
7.4.2.	Routing data away from chosen outputs.....	15
7.5.	USB Configuration: Monitoring and Sending NMEA Messages.....	16
7.6.	USB communication with Autopilots.....	16
8.	Upgrading firmware.....	17
9.	Chart software.....	18
9.1.	OpenCPN example USB setup.....	18
9.2.	OpenCPN example Network setup.....	19
9.3.	Maps.....	19
10.	Specification.....	20
11.	Limited Warranty and Notices.....	21
12.	Glossary.....	21

## 1. Introduction

The sophisticated QK-A033 NMEA multiplexer combines data from multiple NMEA, SeaTalk, WiFi and USB devices.

The A033 can be used out of the box for standard functionality or configured for additional sophistication.

Through advanced filtering and routing, the A033 NMEA enables controlled routing of data to specific outputs, blocking of excess data and overflow reduction.

The A033 multiplexer has three NMEA 0183 inputs (listener-ports), one SeaTalk1 input, two NMEA 0183 outputs (talker-ports), a WiFi interface and USB port to connect to host devices such as PCs, laptops or tablets.

INPUTS (listener ports)	OUTPUTS (talker ports)
3 x NMEA 0183	2 x NMEA 0183
1 x SeaTalk <sup>1</sup>	
WiFi	WiFi
USB	USB

The internal SeaTalk converter allows the A033 to listen on the SeaTalk bus and convert SeaTalk data to NMEA messages.

**Standard Functionality:** The multiplexer converts and combines data received on the listener ports and sends this data to all talker ports, WiFi interface and USB simultaneously.

**Routing options:** The powerful routing feature allows the NMEA, SeaTalk and WiFi input data to be routed from any input to specific outputs.

**Filtering options:** Each input also has a flexible filter that can be configured to pass or block specific sentences. This frees up bandwidth, significantly reducing the possibility of data overflow and resulting loss of data.

**Bi-directional WiFi:** 2 way WiFi and USB connectivity, the A033 allows for wireless connection to autopilots and other NMEA devices if desired.

Data from multiple instruments is available wirelessly through WiFi connections, giving complete freedom to navigate, monitor and control from anywhere on board. Up to 4 iPads, iPhone, Android phones and tablets or other WiFi enabled devices can connect directly to the A033 with no need for an additional access point.

The USB port also supports bi-directional communications. It allows a computer based navigation applications to send sentences through the multiplexer to control an autopilot. The USB port is also used for configuration of specific WiFi and NMEA ports settings.

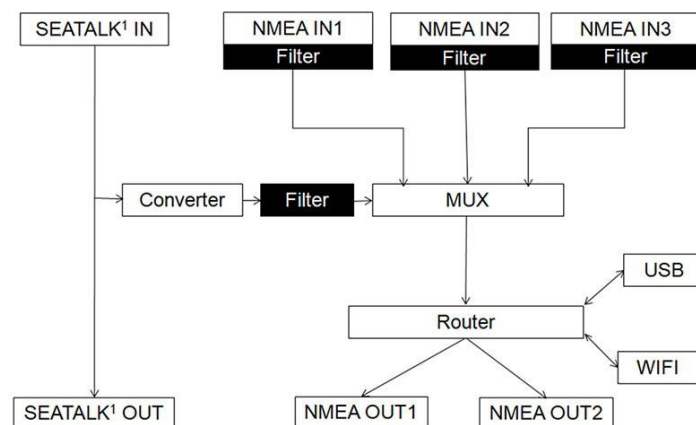

Figure 1 Function diagram

## 2. Mounting

The A033 is aimed at the small-commercial, leisure, fishing boat and vessel monitoring markets. Despite the fact that the A033 case is waterproof, the terminals are open and seawater can cause a short circuit. The A033 should be mounted in a dry place such as behind the instrument panel on a flat surface.

A033 comes with an extruded aluminium enclosure with external dimensions of 114.5 x 110 x 32 mm. Ensure there is enough space around the multiplexer to connect the wirings.

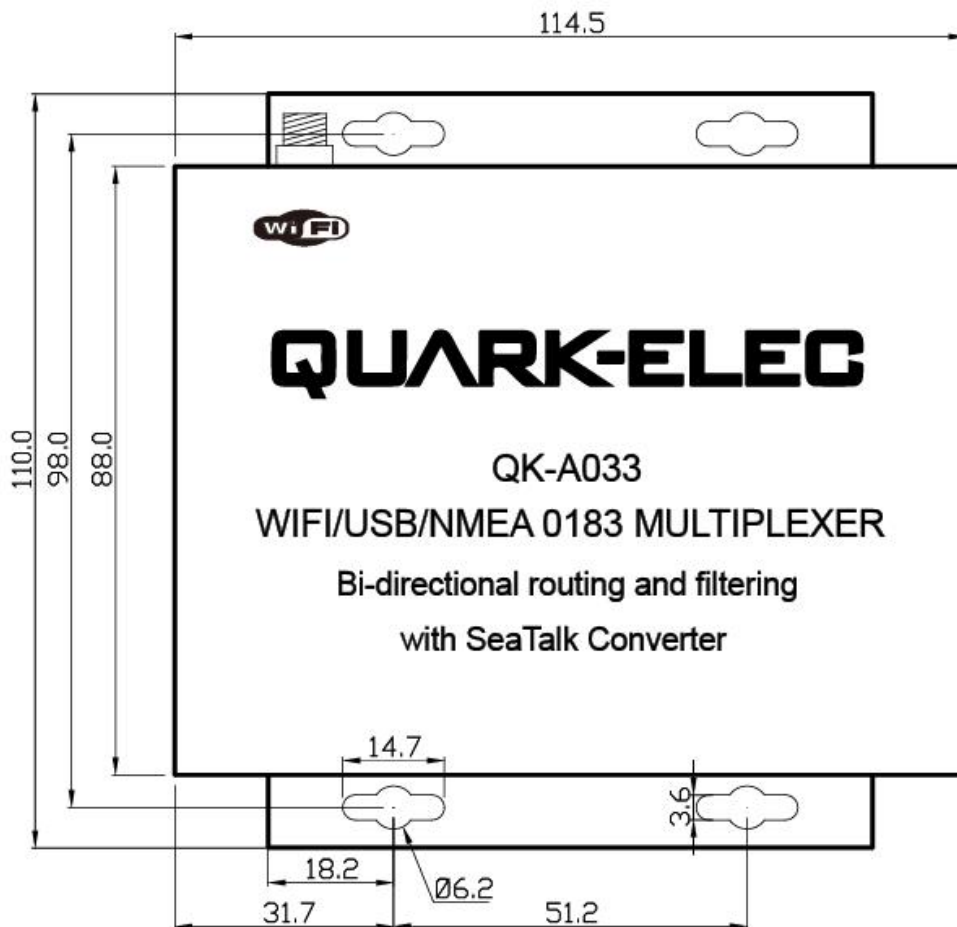

Figure 2 Front drawing

## 3. Connections

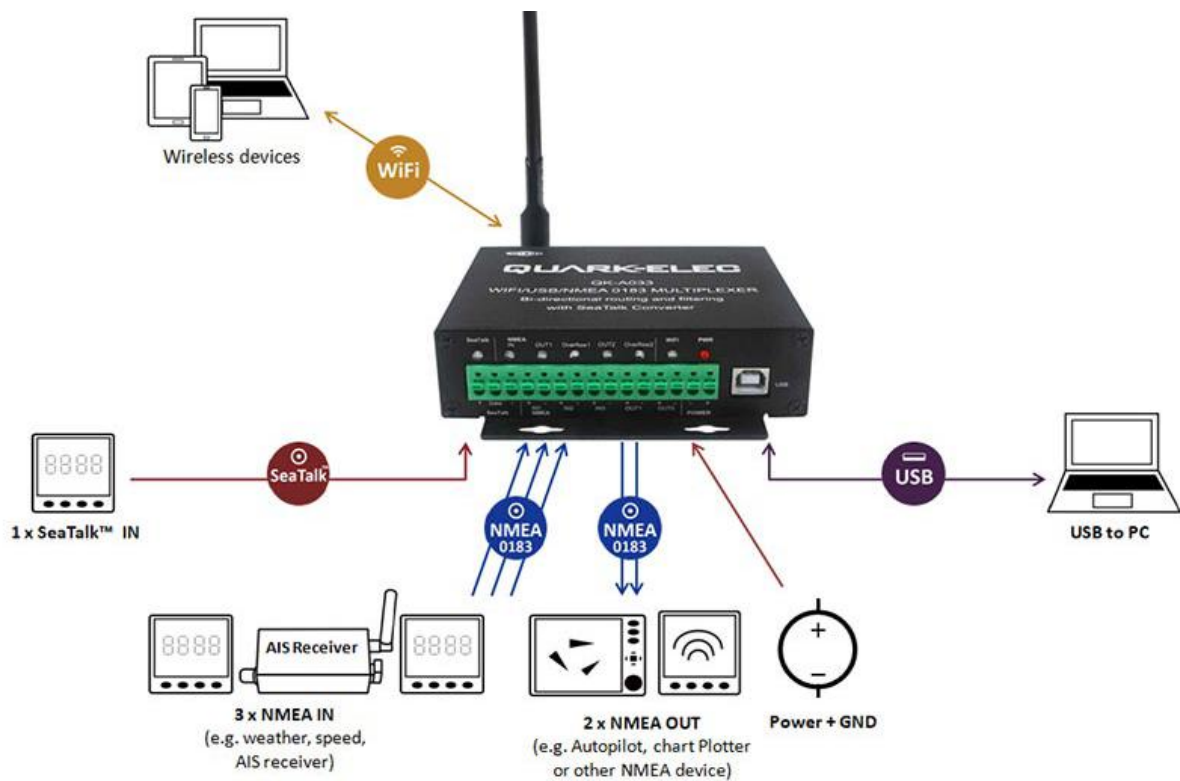
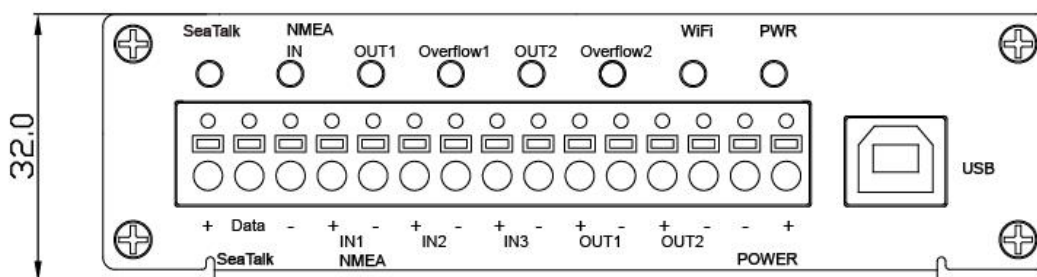

Figure 3 Typical system connection

The A033 multiplexer has the following options for connection to inputs, outputs and host devices.

- 3x NMEA 0183 inputs
- 1x SeaTalk1 input
- 2x NMEA 0183 outputs
- Bi-directional WiFi interface
- Bi-directional USB

Momentary push buttons are used on the terminals; no screw driver is needed for connection.



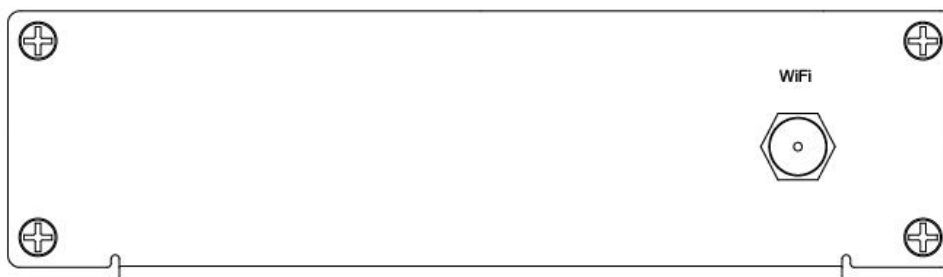

Figure 4 Side view drawing



Power off all the devices before connecting!

### 3.1. SeaTalk<sup>1</sup>

The built-in SeaTalk<sup>1</sup> to NMEA converter translates SeaTalk data into NMEA sentences. The SeaTalk port has 3-Pin terminals for connection to the SeaTalk bus. Ensure the connection is correct before powering up. Inaccurate connection could damage the A033 and other devices on the SeaTalk Bus.

The SeaTalk converter converts the Seataalk messages in the conversion table below. When a SeaTalk message is received, A033 checks if the message is supported. When the message is recognized as being on the SeaTalk data table (below), the message is extracted, stored and converted to an NMEA sentence. Any unsupported datagrams are ignored. These converted NMEA messages are filtered and then combined with NMEA data received on the other inputs.

This function allows the NMEA multiplexer to listen on the SeaTalk bus. Only one SeaTalk input is needed since the SeaTalk bus is a single-cable system that connects all the instruments together through one cable. The SeaTalk to NMEA converter in the A033 works in one direction only. No NMEA sentences are converted into SeaTalk,

Supported SeaTalk Datagrams		
SeaTalk	NMEA	Description
00	STDBT	Depth below transducer
10	STMWV	Wind angle, (10 and 11 combined)
11	STMWV	Wind speed, (10 and 11 combined)
20	STVHW	Speed through water, includes heading when present
21	STVLW	Trip mileage (21 and 22 combined)
22	STVLW	Total mileage (21 and 22 combined)
23	STMTW	Water temperature
25	STVLW	Total and Trip mileage
26	STVHW	Speed through water, includes heading when present
27	STMTW	Water temperature
50	---	GPS latitude, value stored
51	---	GPS longitude, value stored
52	---	GPS speed over ground, value stored
53	STRMC	Course over ground. RMC sentence is generated from stored values from other GPS Related datagram's.
54	---	GPS time, value stored
56	---	GPS date, value stored
58	---	GPS lat/long, values stored
89	STHDG	Magnetic heading, including variation (99)
99	---	Magnetic variation, value stored

The table shows that not all datagrams result in an NMEA 0183 sentence. Some datagrams are only used to retrieve data, which is combined with data from other datagrams to create one NMEA 0183 sentence

### 3.2. NMEA Inputs and Outputs

Every NMEA input on the A033 is galvanically isolated (also called opto-isolation). A galvanically isolated input prevents unwanted currents flowing between the instruments and the multiplexer. These currents can damage equipment or interfere with radio signals and should therefore be avoided.

NMEA baud rates are set to the following default settings:

- NMEA IN 1: 4800bps
- NMEA IN 2: 4800bps
- NMEA IN 3: 38400bps
- NMEA OUT 1: 4800bps
- NMEA OUT 2: 38400bps

These can be adjusted as required, using the Configuration software (see the Configuration section).



Connect the + and - terminals of the NMEA input/output on the A033 to the + and - terminals of the output/input on the instrument (e.g., wind sensor, autopilot, chart plotter). These terminals may also be labelled as A/B, Data+/Data-, RX+/RX-, In+/In-.

#### 3.2.1. NMEA Inputs

A033 has three NMEA inputs called IN1 to IN3. Each input should be connected to one output device only. These inputs are galvanically isolated from the A033 multiplexer, as specified by the NMEA 0183 standard.

Each input has an internal filter which can be configured to pass or block specific sentences from the input devices (See the Configuration section).

A033 combines these filtered NMEA 0183 inputs with the NMEA sentences converted from the SeaTalk input as well as WiFi and USB messages into one NMEA0183 serial data stream.

Regarding connection to external NMEA devices:

Although the NMEA 0183 standard specifies signal names, voltage levels and connection methods clearly; in reality, this standard has been interpreted with variation between manufacturers. To ensure A033 is not damaged please double-check the specifications of the devices before connecting them.

#### 3.2.2. NMEA Outputs

The A033 provides two independent NMEA outputs. These NMEA 0183 outputs are capable of driving the combined data from the inputs.

Each input has an internal filter which can be configured to pass or block specific sentences from the input devices (See the Configuration section).

#### 3.2.3. Addition Functions

See the configuration section below for:

- Filtering input data (blocking certain data from entering the multiplexer)

- Routing of input data to specific outputs (instead of sending all data to all outputs)

## 4. Wireless Connections

The A033 allows users to view their data through WiFi on a PC, tablet, smartphone or other WiFi enabled device. Users can access marine network data including vessel course, speed, position, wind speed, direction, water depth, AIS etc. These can be viewed in your chart software (See 'Chart software' section'). WiFi connections are bi-directions so the chart plotter software can also send cross track and waypoint information to an autopilot to steer a programmed course.

The IEEE 802.11b/g wireless standard has two basic modes of operation; Ad-hoc mode (peer to peer) and station mode (also called infrastructure mode).

The A033 supports WiFi both:

- In **Ad-hoc mode**: wireless devices connect directly (peer to peer) without a router or access point. For example, your smartphone can connect directly to the A033 to receive marine data.
- In **Station mode**: wireless devices communicate through an access point (AP) such as a router that serves as a bridge to other networks (such as the Internet or LAN). This allows your router to handle the data and traffic from your device. This data can then be picked up through your router anywhere on your local area network. Increasing the WiFi range. Similar to plugging the device directly into the router by wire, but instead using wireless technology. In this way, the mobile devices receive both your marine data and other AP connections such as Internet. (See Configuration section)
- WiFi can also be disabled in **Standby mode**. This helps to reduce the power consumption or may be used when connecting 2 WiFi enabled devices. (See Configuration section)

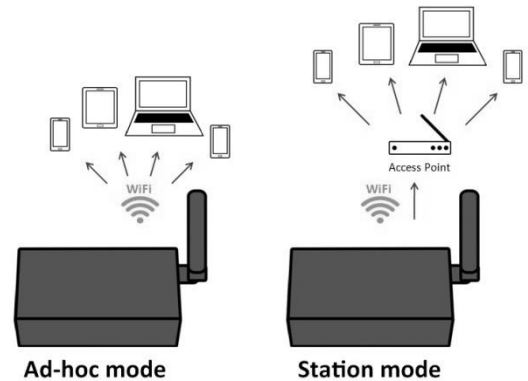

The A033 is set to Ad-hoc mode as a default setting, but can be easily setup to station mode or standby mode through the configuration tool.

### 4.1. WiFi Ad-hoc mode

Around 15 seconds after the A033 has powered up, user will be able to scan for a WiFi network with an (SSID) of 'QK-A033xxxx' or similar, on their mobile devices (phone, laptop etc.).

Connect to '**QK-A033xxxx**' with the default password: '**88888888**'.

<b>Device SSID</b>	Similar to 'QK-A033xxxx'
<b>WiFi password</b>	88888888

In the chart plotter (or navigation software): Set the protocol as '**TCP**', IP address as '**192.168.1.100**' and the port number as '**2000**' in the chart software.

<b>Protocol</b>	TCP
<b>IP address</b>	192.168.1.100
<b>Data Port</b>	2000

With the above settings, a wireless connection should be established and the user will be able to receive the data through the chart software.

**Note: In Ad-hoc mode, the IP address should not be changed.**

**SSID and password can be changed ( password should be 8 to 12 characters long).**

The wireless connection can be checked with TCP/IP port monitoring software as shown. (Figure 5 TCP/IP Net Assistant )

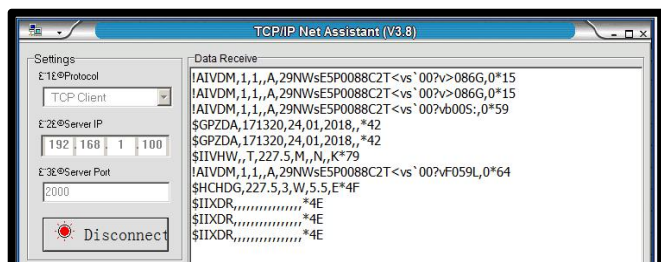

**i** For Station Mode WiFi or for setting WiFi on Standby, see the 'Configuration section'.

## 5. Connecting via USB port

The A033 is supplied with a type B USB connector. The connector can be linked directly to a USB port on the PC.

### 5.1. Will a driver needed to connect via USB?

To enable the USB data connection of A033 to other devices, related hardware drivers may be needed dependent on your system requirements.

**Windows 7,8,10** the driver can be found on the CD in the packing box or be downloaded from <https://www.quark-elec.com>

The A033 registers itself to the computer as a virtual serial com port.

The drivers usually install automatically to your device if it is running an original Windows 10 version. A new COM port will automatically show up in the device manager after plug in.

**Mac:** No driver required.

For Mac OS X, the A033 will be recognized and shown as a USB modem. The ID can be checked with the following steps:

1. Plug the A033 into a USB port and launch Terminal.app.
2. Type: `less /dev/*sub*`
3. The Mac system will return a list of USB devices. A033 will display as - `"/dev/tty.usbmodemXYZ"` where XYZ is a number. Nothing further needs to be done if it is listed.

**Linux:** No driver required. When plugged into the computer, A033 will show up as a USB CDC device on `/dev/ttyACM0`.

### 5.2. Bi-directional USB

The USB connector provides data output as standard (multiplexed information from all input instruments will be sent to this connection). Like WiFi connection, this USB port is bi-directional, so the chart software can send cross track and waypoint information to an autopilot to steer a programmed course through this USB port.

The host port is also used to configure the multiplexer and to update its firmware.

### 5.3. Checking the USB connection (Windows)

After the driver is installed, run the Device Manager and check the **COM number** (this is the number associated with the USB port you are using. The port number is the number that Windows assigns as an input device. These can be generated randomly by your computer). Your chart software may require your COM number in order to access the data.

The port number for the A033 can be found in Windows 'Control Panel->System->Device Manager' under 'Ports (COM & LPT)'. Find the A033 in the list for the USB variant. To change this number, double click the A033 and select the 'Port Settings' tab. Click the 'Advanced' button and change the port number to the one required.

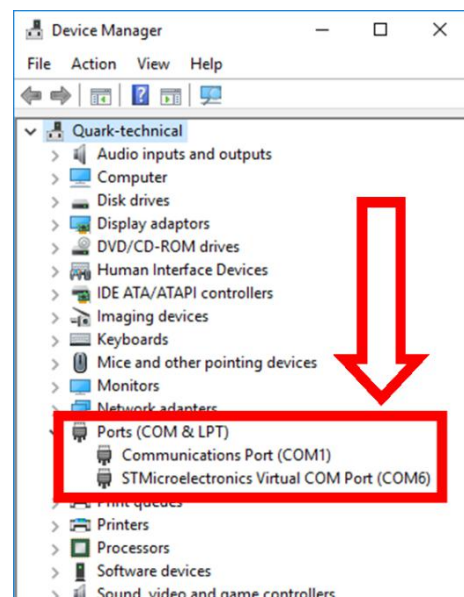

**Checking the USB data flow:** If desired, the USB data can always be checked with the configuration tool. To do this, run the configuration tool, connect to A033 and then click 'Open Port', the input data will be shown on the display field.

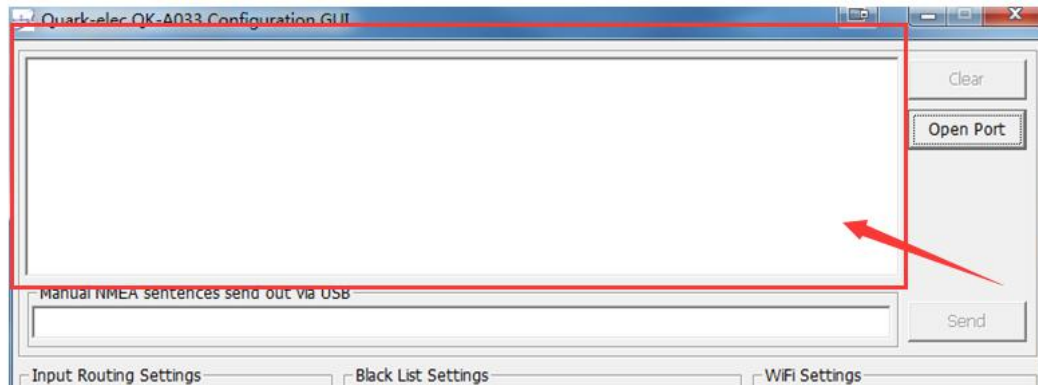

Figure 6 Monitor USB data flow

## 6. Status LED's

A033 features eight LEDs which indicate SeaTalk in, NMEA In, OUT1/2, Overflow1/2, WiFi and Power status respectively.

The status LEDs on the panel show port activity and system status.



Figure 7 LED indications

**SeaTalk and NMEA OUT:** LEDs will flash blue for each valid message received.

**OUT 1/2:** LED will flash in blue for each valid NMEA message sent to that respective output.

**Overflow1/2:** LED will flash in blue when excess messages were sent and messages were overflowed. Some messages will have been lost during overflow. If you regularly notice the overflow LED flashing, see the 'Routing' and/or 'Filtering' sections of the manual for how to manage your message flow and best utilise your outputs' bandwidth.

**WiFi:** LED will flash in blue for each valid message sent or TCP connection achieved.

**PWR (Power):** LED light is constantly lit in red when the device is powered.

## 7. Configuration

The A033 Configuration tool software can be found on the free CD provided with your product or at <https://www.quark-elec.com/downloads/configuration-tools/>.

The A033 Windows configuration tool can be used to setup the port routing, sentence filtering, NMEA baud rates, and WiFi settings for the A033. It can also be used to monitor and send NMEA sentences through the USB port. The configuration tool must be used on a windows PC (or a Mac using BootCamp or other Windows simulating software) while the A033 is connected via USB cable. The software cannot access the A033 via WiFi.

The configuration tool must not be opened while another program is using the A033. Please close down all applications using the A033 when using the configuration tool.

Once open, click 'Connect'.

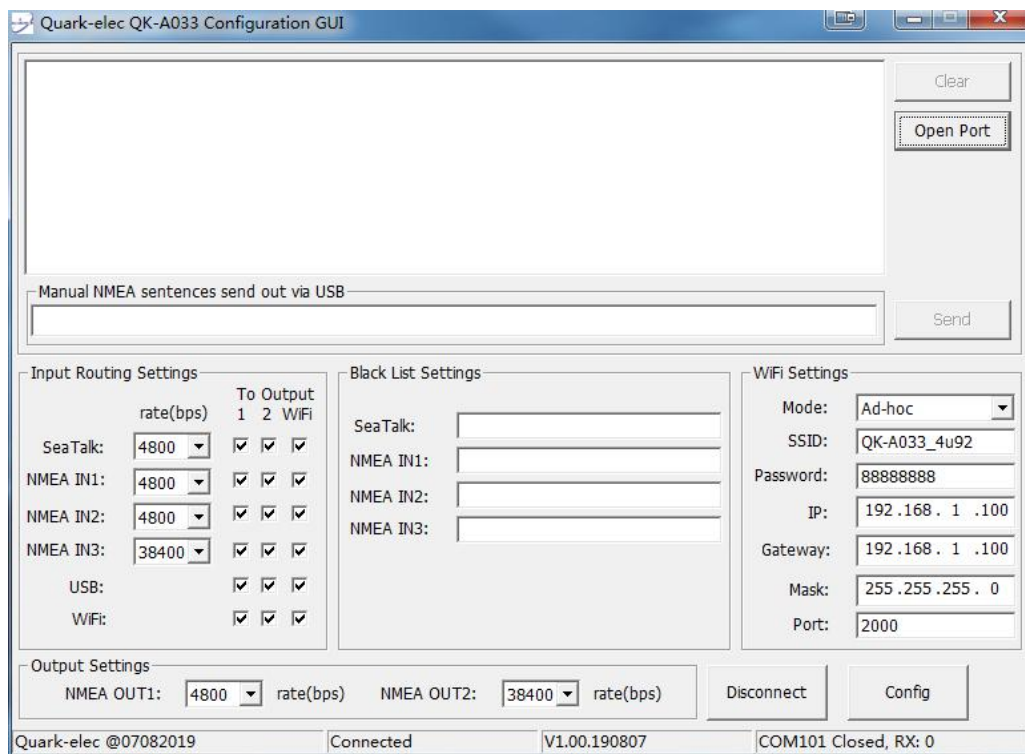

Figure 8 Configuration tool connection

## 7.1. Configuring Baud Rates

NMEA 0183 input and output baud rates can be setup from dropdown menu. A033 can work with the standard NMEA 0183 devices (4800bps) or the high-speed NMEA 0183 devices (38400bps), 9600bps can also be chosen.

NMEA baud rates are set to the following default settings:

- NMEA IN 1: 4800bps
- NMEA IN 2: 4800bps
- NMEA IN 3: 38400bps
- NMEA OUT 1: 4800bps
- NMEA OUT 2: 38400bps

These can be adjusted as required.

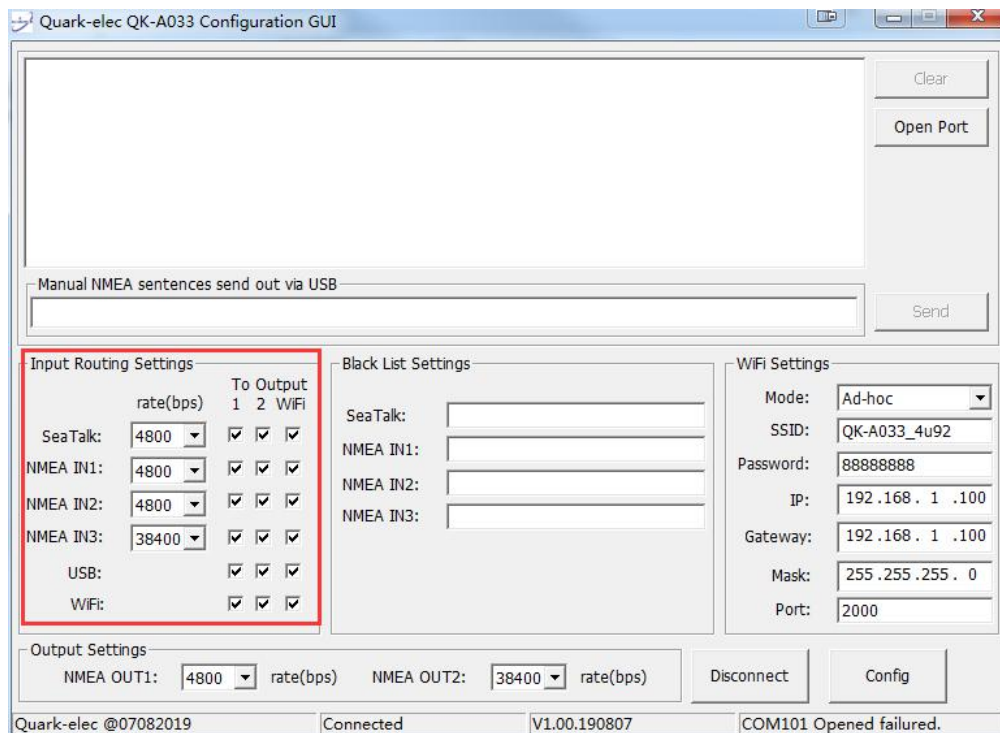

Figure 9 Setup the baud rate

When A033 is connected to a computer (Windows system) and powered up, 'A033 connected' will be shown at the centre of the bottom and the software version shows at the bottom right. Press '**Config**' once you have set the Baud rates for the inputs and outputs to save them to the A033.

Then press the '**Disconnect**' button to safely remove the device from the PC.

Re-start the A033 to active the new settings to the device.

## 7.2. WiFi - Station mode

WiFi is set to ad-hoc mode as standard. Station mode allows your router/access point to handle the data and traffic from your device. This data can then be picked up through your router anywhere on your local area network. Similar to plugging the device directly into the router, but instead using wireless technology.

This allows your main mobile device to still receive Internet and for you to be able to view the data.

To begin setup station mode the A033 should be attached to a computer running Windows (Mac users can use BootCamp) via USB.

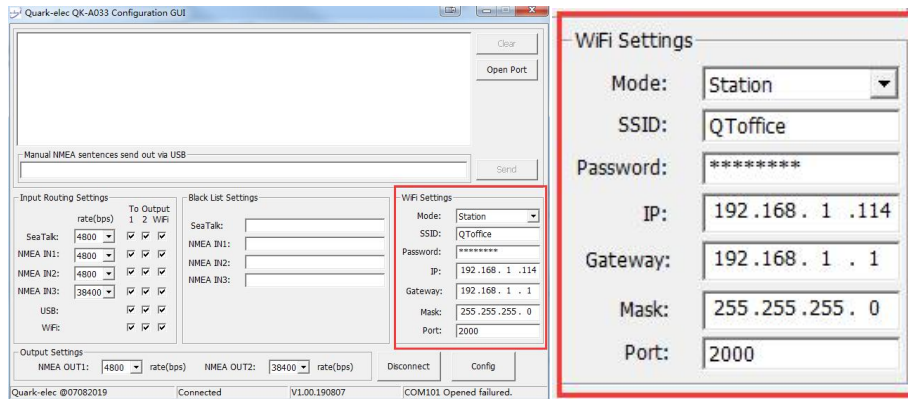

1. Connect A033 to computer via Micro USB B connection.
2. Run the Configuration software (having closed any other programs that would access the A033. ) and check connection to the A033 at the bottom of Configuration tool.
3. Change working mode to '**Station mode**'
4. Enter your router's **SSID**.
5. Enter the **password** for your network.
6. Enter the **IP address** A033 will be assigned to the A033. This normally start with 192.168. The third group of digits depends on your router's configuration( commonly 1 or 0). The fourth group must be a unique number between 0 and 255) This number must not be used by any other equipment connected to your router.
7. Enter your **router's IP address** in the **Gateway** section. This can usually be found under the router. Leave the other settings as they are.
8. Click '**Config**' in the bottom right hand corner and wait 60 seconds. After 60 seconds Click '**Disconnect**'.
9. Repower the A033 and it will now attempt to connect to the router.

10. In your chart software set the protocol as '**TCP**'  
 Insert the **IP address** you assigned the A033  
 Enter the Port number as '**2000**' in the chart software.

<b>Protocol</b>	TCP
<b>IP address</b>	(check your router)
<b>Data Port</b>	2000

You should now be connected and see your marine data in your chart software. If not then check your router's **IP address list** and confirm the **IP address** that your router has assigned the A033.

Occasionally, a router assign a different **IP address** to a device than the one you chose to assign it during Configuration. If this is the case, copy the **IP address** from the router into your chart software. If the **IP address** in the router's **IP address list** is the same as the one you input into your chart software then everything will work in station mode. If you are unable to see any data repeat the steps, please check all the data has been input correctly.



If you are not able to view your data in station mode, the likely cause is either the data has been input incorrectly, or the IP address is different in your chart software to that of your router.

## 7.3. WiFi - Standby

By setting up the WiFi as standby, the WiFi module will be disabled.

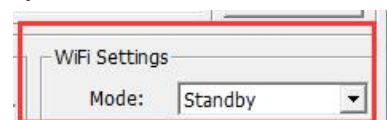

## 7.4. Configuring Routing and Filtering

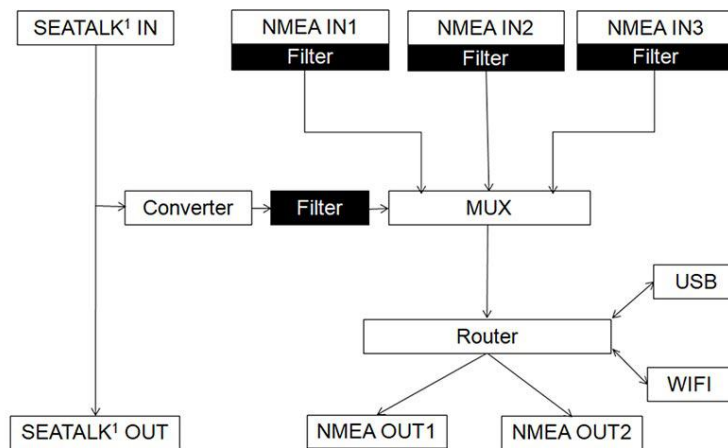

Figure 10 Routing & Filtering

The A033 features filtering and routing. Specific input data can **filtered** out and ignored by the multiplexer, remaining wanted data can then be **routed** to specific outputs.

**Filtering options:** Each input also has a flexible filter that can be configured to pass or block specific sentences from entering the multiplexer. This frees up bandwidth, significantly reducing the possibility of data overflow and resulting loss of data

**Routing options:** The powerful routing feature allows the remaining NMEA, SeaTalk and WiFi input data to be routed from any input and limited to the desired outputs.

Filter and routing allows the A033 reduce the processing data load by disabling these unneeded input sentences from specific NMEA outputs. GPS receivers for example often transmit an abundance of sentences every second and can fill much of the available bandwidth of an NMEA 0183 port at 4800bps. By filtering out any unnecessary data, bandwidth is saved for other devices' data.

It also solves the conflict in the case where two similar NMEA devices provide the same types of sentences. Operators may choose to enable this data on one input only (filtering), and/or to route each input to a specific output (routing).

### 7.4.1. Filtering: Black list setup

Each input port's black list can block up to 8 types sentences.

Most of Chart plotters have their own sentence filter, however for most PC/mobile phone based applications, this is not the case. So using the black list to filter un-necessary sentences is very helpful.

Remove the '\$' or '!' from the 5 digit NMEA talker and sentence identifier and insert separated by commas.

- For example to block '!AIVDM' and '\$GPAAM' enter 'AIVDM,GPAAM'.
- If blacklisting SeaTalk data, the corresponding NMEA message header should be input (see SeaTalk section for a full list of converted messages).

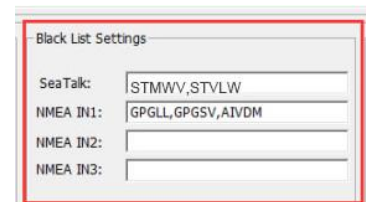

### 7.4.2. Routing data away from chosen outputs

As a default, all inputs' data (excluding any filtered data) is routed to all outputs (NMEA x2, WiFi and USB). Data can be routed to limit the data flow to only certain output/s.

	rate(bps)	To Output		
		1	2	WiFi
SeaTalk:	4800	<input checked="" type="checkbox"/>	<input checked="" type="checkbox"/>	<input checked="" type="checkbox"/>
NMEA IN1:	4800	<input checked="" type="checkbox"/>	<input checked="" type="checkbox"/>	<input checked="" type="checkbox"/>
NMEA IN2:	4800	<input checked="" type="checkbox"/>	<input checked="" type="checkbox"/>	<input checked="" type="checkbox"/>
NMEA IN3:	38400	<input checked="" type="checkbox"/>	<input checked="" type="checkbox"/>	<input checked="" type="checkbox"/>
USB:		<input checked="" type="checkbox"/>	<input checked="" type="checkbox"/>	<input checked="" type="checkbox"/>
WiFi:		<input checked="" type="checkbox"/>	<input checked="" type="checkbox"/>	<input checked="" type="checkbox"/>

Simply un-tick the corresponding boxes in the Configuration software.

### 7.5. USB Configuration: Monitoring and Sending NMEA Messages

Connect A033 and then click 'Open port', all the output sentences will be monitor and displayed in the application.

Users can also manually send the NMEA 0183 format sentence, either for testing or for specific data transfer, e.g autopilot control sentences or waypoint information, through the tool. Input the sentence in the field and then click 'Send'.

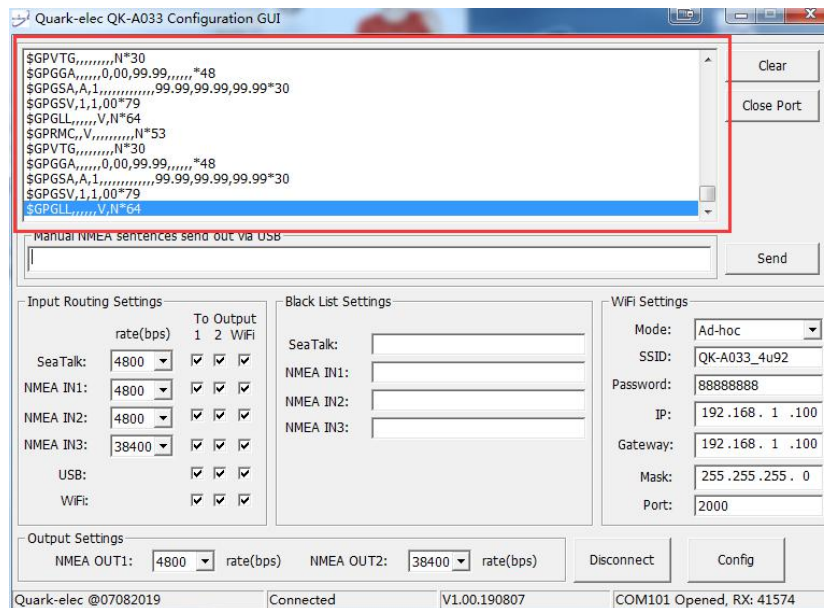

Figure 11 Monitor via USB

### 7.6. USB communication with Autopilots

The communication speed of the USB interface is up to 100 times faster than a standard NMEA 0183 output. With a waypoint activated, a navigation application can send many sentences at a time to the multiplexer to control an autopilot. This will cause the host buffer in the multiplexer to fill very rapidly. Eventually, sentences will be lost if no flow control applied.



A033 has a large buffer to decrease the possibility of overflow, however, It is strongly suggested the user applies flow control (CTS/RTS) in their navigation application. Monitoring the overflow LED indicator is another very helpful way to check the status of the communication.

## 8. Upgrading firmware

The current firmware version can be checked through the configuration tool (When connected with the A033, the firmware version will be shown on the bottom of the Configuration software window).

To upgrade the firmware,

1. Run the Configuration software.
2. Ensure it is connected to the A033, and then click Ctrl+F7.
3. A new Window will pop up with a drive named 'STM32' or similar. Copy the firmware into this drive and wait around 10 seconds to make sure the full file has been copied.
4. Disconnect from the Configuration software.
5. Restart the A033, then the new firmware will be active.

## 9. Chart software

There is a wide range of chart software is available.

We will use OpenCPN for our example; other software will require similar setup.

<https://opencpn.org/> OpenCPN (Open Chart Plotter Navigator) is a free software project to create concise chart plotter and navigation software, for use underway or as a planning tool. OpenCPN is developed by a team of active sailors using real world conditions for program testing and refinement.

### 9.1. OpenCPN example USB setup

1. When you first open the software you will be greeted with a page similar to the one below. This is the main view of openCPN software. You now need to add data to openCPN via your Quark-elec instruments. Click on the 'Options' tab at the top. The settings tab looks like a spanner as seen below in the highlighted image.

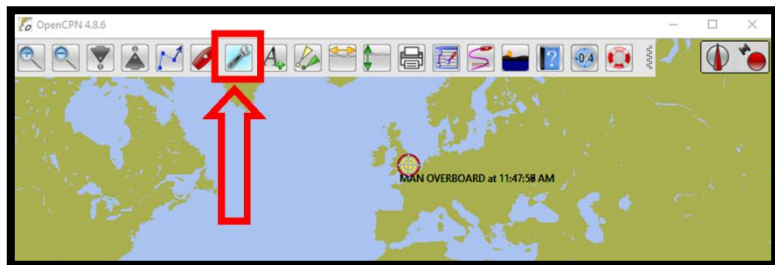

2. In the options at the top of the menu will be a tab/button that says '**Connections**'. Click on this

3. Click on '**Add Connection**' button highlighted in the picture below.

4. Select '**Serial**'

5. Select from the drop down the **COM** number assigned to A033 (See [connecting via USB](#) to find com port in device manager). Adjust the Baud rate accordingly (38400 covers AIS)

6. Click '**Apply**' and then '**OK**'

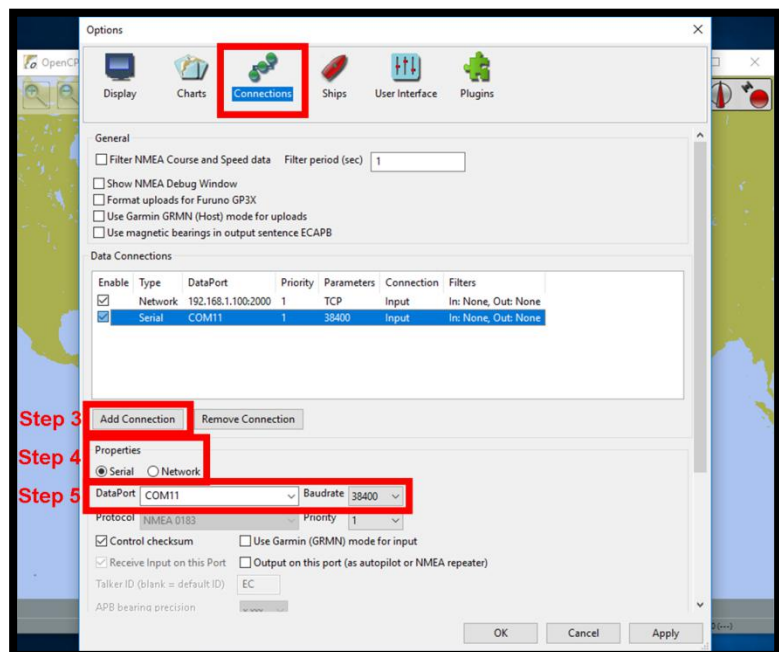

## 9.2. OpenCPN example Network setup

Using the same options tab as above we can set up a wireless network connection via Ad-hoc. Go to the 'Connections' tab at the top of the options menu and click.

1. Click the 'Add connection' button.
2. Select 'Network'
3. Input the Protocol: **TCP**
4. Insert IP address. In Ad-hoc this is 192.168.1.100. In Station mode then this will be a different IP address
5. Input the 'Dataport': **2000**
6. Click 'Apply' and then 'OK'

<b>Protocol</b>	<b>TCP</b>
<b>IP address</b>	<b>192.168.1.100</b> This is the IP address for Ad-hoc WiFi. In Station mode, simply replace with the relevant IP (See Station mode.).
<b>Data Port</b>	<b>2000</b>

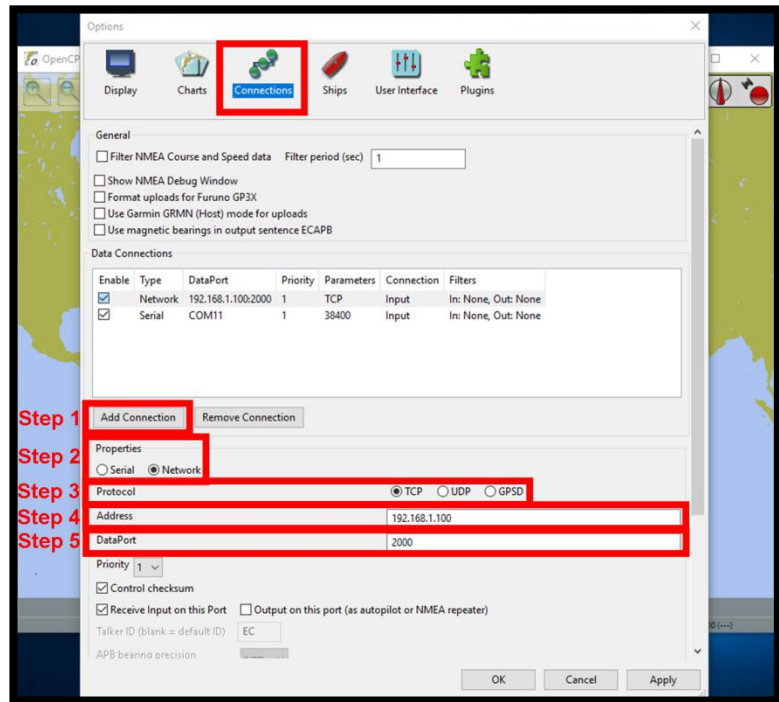

To control the autopilot through OpenCPN, tick 'Output on this port(as autopilot or NMEA repeater)' OpenCPN will output the control sentences via USB/WiFi.

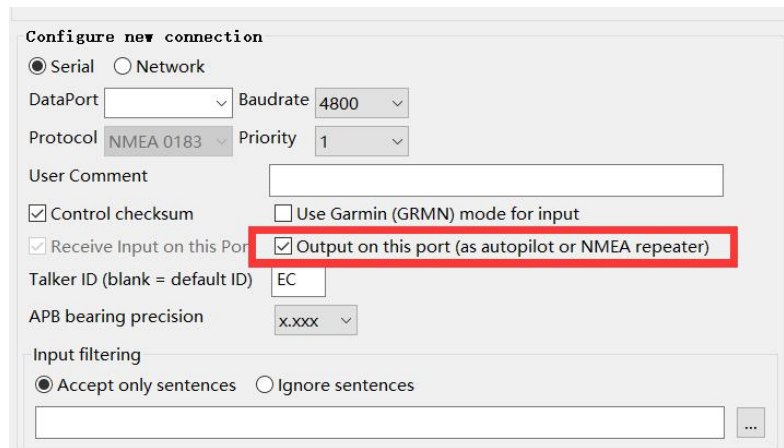

## 9.3. Maps

The OpenCPN interface comes with a basic map view. You can easily download more detailed maps.

There is a wide range of free and licensed charts available in different formats via the OpenCPN website at <https://opencpn.org/OpenCPN/info/chartsources.html>.

A worldwide directory of free nautical charts can also be found on [openseachart.org](http://openseachart.org). The collection and the updates are community driven.

## 10. Specification

Item	Specification
DC supply	10-30V(+/-0.2V)
Average supply current (typical quiescent)	160mA
NMEA data format	ITU/ NMEA 0183 format
NMEA input data rate	4.8k to 38.4kbps, RS-422 galvanically isolated
NMEA output data rate	4.8k to 38.4kbps, RS-422 galvanically isolated
Seata1k1 data rate	Default 4.8kbps, can be set up to 38.4kbps.
WiFi mode	Ad-hoc/Station mode on 802.11 b/g/n.
Security	WPA/WPA2
Operating temperature	-25°C to +80°C
Storage temperature	-25°C to +85°C

## 11. Limited Warranty and Notices

Quark-elec warrants this product to be free from defects in materials and manufacture for one year from the date of purchase. Quark-elec will, at its sole option, repair or replace any components that fail in normal use. Such repairs or replacement will be made at no charge to the customer for parts and labour. The customer is, however, responsible for any transportation costs incurred in returning the unit to Quark-Elec. This warranty does not cover failures due to abuse, misuse, accident or unauthorized alteration or repairs. A returns number must be given before any unit is sent back for repair.

The above does not affect the statutory rights of the consumer.

### Disclaimer

This product is designed to aid navigation and should be used to augment normal navigational procedures and practices. It is the user's responsibility to use this product prudently. Neither Quark-, nor their distributors or dealers accept responsibility or liability either to the products user or their estate for any accident, loss, injury or damage whatsoever arising out of the use or of liability to use this product.

Quark- products may be upgraded from time to time and future versions may therefore not correspond exactly with this manual. The manufacturer of this product disclaims any liability for consequences arising from omissions or inaccuracies in this manual and any other documentation provided with this product.

### Document history

Issue	Date	Changes / Comments
1.0	07-07-2019	Initial release

## 12. Glossary

- **Ad-hoc WiFi:** devices communicate directly with each other without a router.
- **Station mode WiFi:** devices communicate by going through an Access Point(AP) or router.
- **IP:** internet protocol (ipv4, ipv6)
- **IP Address:** is a numerical label assigned to each device connected to a computer network.
- **Router:** A router is a networking device that forwards data packets between computers and devices on a network.
- **USB:** cable for communication and power supply between devices.
- **NMEA 0183:** is a combined electrical and data specification for communication between marine electronics

Quark-elec (UK)  
 Unit 7, the Quadrant  
 Newark close  
 Royston, UK  
 SG8 5HL

